

Kountry WOOD

CABINETS WORTH OWNING



2024 PRODUCT SPECIFICATIONS

Kountry WOOD

CABINETS WORTH OWNING

Thank you for considering Kountry Wood Products for your cabinetry needs.

For the last 25 years, Kountry Wood has been manufacturing stock kitchen and bathroom cabinetry in Nappanee, Indiana - The Heartland of America. We are a family-owned business that values the heritage of our country.

Our business was founded on the basic philosophy of building a quality product, selling it at a reasonable price, delivering it on time, and providing excellent customer service.

We take our business seriously by providing American workers jobs in our community and by purchasing material from local suppliers. We are certified by the KCMA Environmental Stewardship Program, and reviewed annually to meet or exceed standards of air quality, product resource management and environmental stewardship to ensure a sustainable product for years to come.

We hope that you find our products to be the right choice for you.

Sincerely,

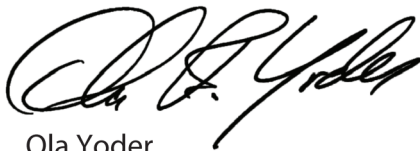

Ola Yoder
CEO



Table of Contents

Cabinet Care..... 3

Wood and Paint..... 4

Part Number - SKU Nomenclature 4

Cabinet Options..... 5

Product Matrix..... 6

Door Styles..... 8

Finish Options..... 15

Cabinet Dimensions 16

Cabinet Specifications 18

Wall Cabinets 20

Blind Wall Cabinets 24

Base Cabinets..... 25

Blind Base Cabinets 28

Microwave/Oven Cabinets..... 29

Utility Cabinets..... 30

Shelf Kits 31

Office Cabinets 32

Vanity Cabinets 33

Furniture Vanity Cabinets 37

Specialty Cabinets..... 39

Accessories 40

Organizers/Sales Kiosk 43

Fillers..... 44

Panels..... 44

Moldings..... 46

Warranty 49

Cabinet Care

Quality wood cabinet finishes that have been made to last, can, like good clothes, very quickly get a “used” appearance. Good things need looking after if they are to keep their quality. Due to its many properties, wood has always been a popular material for fine cabinetry the world over. Each tree is an individual piece of nature, which, after being felled, keeps its own character in its strength, structure and sensitivity to light and moisture. Wood can also change its character with time.

Moisture is the worst enemy of all wooden furniture, so all spilled liquids should be wiped away at once. Cabinets should be protected against heat, and also against wet or colored objects.

Cabinet surfaces should be cleaned with a very mild soapy solution. The cloth should be soft and dampened with the soap solution. The surface should then be wiped down with a dry cloth to remove excess moisture. Other cleaning compounds exist but may contain alkaline reagents which will adversely affect the surface. Household polishes can be used on an infrequent basis. Products containing silicone are moisture and dirt resistant but may hinder future lacquering.



KITCHEN CABINET MANUFACTURERS ASSOCIATION.
ENVIRONMENTAL STEWARDSHIP PROGRAM (ESP).
ALL PRODUCTS IMPACT THE ENVIRONMENT
FOR ESP PROGRAM CRITERIA, VISIT KCMA.ORG



KITCHEN CABINET
MANUFACTURERS ASSOCIATION™



Wood and Paint Characteristics & Variations

Wood - Naturally occurring variations in wood such as color, grain, mineral streaks and knots are not considered defects.

Color variations are a natural occurrence due to species, age, character of cabinets, and exposure to UV light and sunlight. Such variations and changes are not considered defects. For these reasons, new and/or replacement cabinets may not match display samples and/or existing cabinets.

Warping is the bending or twisting of a part. To measure a door or shelf, lay the product on a flat surface and measure the gap from the surface to the part. The standard allowable tolerance for wood is 1/8" per lineal foot. Materials that fall within specification are considered acceptable, as a part of the natural characteristics of wood.

Paint Finishes - Paint finishes are uniquely different from standard wood finishes. On all wood products, expansion and contraction are typical due to changes in climate conditions. Due to this normal movement, paint finishes may develop slight separation lines, finish breaks and seam lines. These will be most notable at stile, rail and panel joints. Joint separations may become more noticeable over time and through season changes.

With the use of select hardwoods and veneers, some of the grain pattern and wood characteristics (checks & pin knots) as well as seams & joints will remain visible through the paint finish. These are normal and are not considered quality defects.

Seam lines and finish breaks are normal characteristics of paint finishes and should not be considered a reason for product replacement. Over time, there may be a slight color shift, due to exposure to natural and artificial light.

Part Number - SKU Nomenclature								
	----- ITEM NUMBER -----				Door Style	Door Option	Color Species	Cabinet Options
	Cabinet Type	Cabinet Width	Wall Height Base Depth	Wall Depth Base Height *				
CHARACTERS	1-3	4-5	6-7	8-9	10-11	12-13	14-16	17-22
EXAMPLE	WAL	30	30	12	GX	07	STX	VM
WAL303012GX07STXVM - Wall 30" [WAL303012], Georgetown [GX], Glass Butt Door [07], Slate Maple [STX], Premium & Plywood Veneer [V] (required by Matching Interior) + Matching Interior [M] = [VM]								

* Base Height (chars 8-9): Standard (2 digits) or Furniture Vanity (F4, F5)

Door Style Codes					
CX = Classic	DX = Durham	GX = Georgetown	HX = Harmony	JX = Jamestown	KX = Kingston
MX = Mission	RX = Rentown	UX = Urbana	VX = Vanderburgh	WX = Williamsburg	YX = Youngstown

Color Species Codes				
CHERRY/STAINED	MAPLE/STAINED		OAK/STAINED	HDF/PAINTED
LXX = Lava	ABX = Auburn	PCX = Pecan	CBX = Cobblestone	LSX = Limestone
	CFX = Coffee	STX = Slate	DWX = Driftwood	PEX = Pearl
	NXX = Natural	SSX = Sandstone	FXX = Fairfield	WHX = White
	ONX = Onyx	TFX = Toffee	KXX = Kountry	

Cabinet Options

OPTION	DESCRIPTION	
02	FULL HEIGHT DOOR: BASE CABINETS ONLY	
03	GLASS DOOR PREP: AVAILABLE ON WALL CABINETS AND TOP DOORS OF UHC ONLY	
05	MULLION DOOR (SEE DOOR CONSTRUCTION SPECIFICATIONS FOR IMAGES) AVAILABLE ON WALL CABINETS AND TOP DOORS OF UHC AND UHB ONLY	SINGLE DOOR CABINET (<= 24" W)
		2 OR 4 DOOR CABINET (>=27" W)
100	¾" MDF SHELF: AVAILABLE ON STANDARD CONSTRUCTION ONLY	
102	¾" PLYWOOD SHELF: AVAILABLE ON PREMIUM CONSTRUCTION ONLY	
VM	MATCHING INTERIOR (M): [STAIN FINISHES ONLY] - REQUIRES PREMIUM AND PLYWOOD VENEER [V]	
DI	MATCHING PAPER INTERIOR (I): [Limestone, Pearl ONLY] - REQUIRES PREMIUM (D)	
---	PENINSULA CABINET: ACCESSIBLE FROM 2 SIDES <ul style="list-style-type: none"> SHELVES ARE NOT AVAILABLE ON PENINSULA BASE CABINETS ADJUST CHARACTERS 2 AND 3 OF ITEM NUMBER TO PC, PE, PS, PT AS SPECIFIED IN CATALOG. EXAMPLES: WAL243612 → WPE243612; BSB362434 → BPS362434 	
FR	CABINET FRONT ONLY: NO CABINET BOX; INCLUDES FACE FRAME, HINGED DOORS, AND DRAWER FRONTS	







SOFT CLOSE OPTIONS * BOTH OPTIONS NEED TO BE SELECTED FOR THE SOFT CLOSE PACKAGE *

OPTION	DESCRIPTION
28	SOFT CLOSE HINGES <ul style="list-style-type: none"> DOORS WITH 2 HINGES RECEIVE 1 SOFT CLOSE HINGE. (EXCEPTION: DOORS LARGER THAN 17" X 21" RECEIVE 2 SOFT CLOSE HINGES) DOORS WITH 3 HINGES RECEIVE 2 SOFT CLOSE HINGES.
S	SOFT CLOSE WOOD DRAWERS (FULL EXTENSION) <ul style="list-style-type: none"> NOT AVAILABLE IN 18" DEEP VANITIES

OPTION	DESCRIPTION
W	ALL WOOD DRAWER BOX: INCLUDED ON CABINETS 27" - 36" W
06	5 PIECE DRAWER FRONT: NOT AVAILABLE ON MISSION AND DURHAM

PREFIX	DESCRIPTION
ROS	ROLL OUT SHELF FOR BASE CABINET *75LBS WEIGHT CAPACITY* FACTORY INSTALLATION OPTION <ul style="list-style-type: none"> 1 Level: Tray(s) installed at the bottom of the cabinet. 2 Levels: 1st level of tray(s) installed at the bottom of the cabinet. 2nd level of tray(s) spaced evenly above.
ROSU	ROLL OUT SHELF FOR UTILITY CABINET *75LBS WEIGHT CAPACITY* FACTORY INSTALLATION OPTION (For each level of shelving, 1 tray is installed per door opening.) <ul style="list-style-type: none"> 2 Levels: 1st level of tray(s) installed at the bottom of the cabinet. 2nd level of tray(s) spaced evenly above (21" space). 4 Levels: 1st level of tray(s) installed at the bottom of the cabinet. 2nd - 4th level of tray(s) spaced evenly above. (10" space).

OPTION	DESCRIPTION
P	PLYWOOD VENEER SIDES: Not available on painted cabinets
V	PLYWOOD VENEER SIDES: (Use with Premium Option) Not available on painted cabinets







Product Matrix						
Price Column ▶	A		B			
Door Style ▶	Harmony	Mission	Durham Full Overlay Only	Georgetown	Youngstown	Vanderburgh
Finish & Species ▼						
	FLAT PANEL (5-Piece Drawer Optional)	SLAB	SLAB	SHAKER (5-Piece Drawer Optional)	SHAKER FLAT PANEL (5-Piece Drawer Optional)	MITERED FLAT PANEL (5-Piece Drawer Optional)
Auburn Maple	✓	✓	✓	✓	✓	✓
Coffee Maple	✓	✓	✓	✓	✓	✓
Natural Maple	✓	✓	✓	✓	✓	✓
Onyx Maple	✓	✓	✓	✓	✓	✓
Pecan Maple	✓	✓	✓	✓	✓	✓
Sandstone Maple	✓	✓	✓	✓	✓	✓
Slate Maple	✓	✓	✓	✓	✓	✓
Toffee Maple	✓	✓	✓	✓	✓	✓
Lava Cherry	✓			✓	✓	✓
Cobblestone Oak	✓			✓	✓	
Fairfield Oak	✓			✓	✓	
Kountry Oak	✓			✓	✓	
Driftwood Oak	✓			✓	✓	
Painted Limestone*† (Elegant Maple Interior)		✓	✓	✓	✓	✓ Maple
Painted Pearl*† (Elegant Maple Interior)		✓	✓	✓	✓	✓ Maple
Painted White*† (White Interior)		✓	✓	✓	✓	✓ Maple

✓ Finish Available in Door Style

* Additional charges apply

NOTE: Plywood Veneer Sides N/A in White, Limestone, or Pearl

† Composite Board on Painted Except as Noted

Product Matrix						
Price Column ▶	C		D			E
Door Style ▶	Kingston Full Overlay Only	Urbana Full Overlay Only	Classic	Jamestown Full Overlay Only	Rentown Full Overlay Only	Williamsburg Full Overlay Only
Finish & Species ▼						
	SHAKER (5-Piece Drawer Optional)	NARROW SHAKER (5-Piece Drawer Optional)	RAISED PANEL (5-Piece Drawer Optional)	WIDE RAIL SHAKER (5-Piece Drawer Optional)	WIDE RAIL FLAT PANEL (5-Piece Drawer Optional)	MITERED RAISED PANEL (5-Piece Drawer Optional)
Auburn Maple	✓	✓	✓	✓	✓	✓
Coffee Maple	✓	✓	✓	✓	✓	✓
Natural Maple	✓	✓	✓	✓	✓	✓
Onyx Maple	✓	✓	✓	✓	✓	✓
Pecan Maple	✓	✓	✓	✓	✓	✓
Sandstone Maple	✓	✓	✓	✓	✓	✓
Slate Maple	✓	✓	✓	✓	✓	✓
Toffee Maple	✓	✓	✓	✓	✓	✓
Lava Cherry	✓		✓	✓		✓
Cobblestone Oak	✓		✓	✓		
Fairfield Oak	✓		✓	✓		
Kountry Oak	✓		✓	✓		
Driftwood Oak	✓		✓	✓		
Painted Limestone*† (Elegant Maple Interior)	✓	✓		✓	✓	
Painted Pearl*† (Elegant Maple Interior)	✓	✓		✓	✓	
Painted White*† (White Interior)	✓	✓		✓	✓	

✓ Finish Available in Door Style

* Additional charges apply

NOTE: Plywood Veneer Sides N/A in White, Limestone, or Pearl

† Composite Board on Painted Except as Noted

Harmony

Flat Panel

Construction:

$\frac{3}{4}$ " x $2\frac{1}{4}$ " solid wood rails with mortise and tenon corner joints.

Available in standard overlay only

Center panel:

$\frac{1}{4}$ " veneer

Rubber balls stabilize panel and allow for wood expansion and contraction

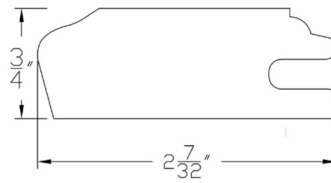

Door Profile



Standard Drawer Front

*Edge detail on drawer front matches profile.



Optional 5-piece Drawer Front

Mission

Slab

Construction:

$\frac{5}{8}$ " particle board with maple veneer

Painted finishes: composite board

Available in standard overlay only

Edges:

Banded with a maple veneer

Optional 5-piece Drawer Front not available



Standard Drawer Front

Durham

Slab

Construction:

5/8" particle board with maple veneer

Painted finishes: composite board

Available in full overlay only

Edges:

Banded with a maple veneer

Optional 5-piece Drawer Front not available



Standard Drawer Front

Georgetown

Shaker

Construction:

3/4" x 2 1/4" solid wood rails with mortise and tenon corner joints

Painted finishes: composite board

Available in standard overlay only

Center panel:

1/4" veneer

Rubber balls stabilize panel and allow for wood expansion and contraction

Painted finishes: composite board

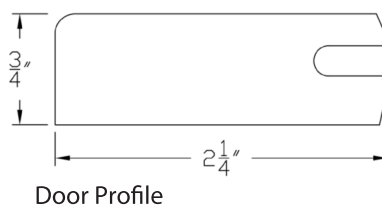

Standard Drawer Front

*Edge detail on drawer front matches profile.

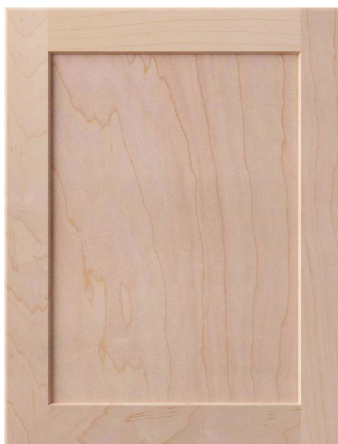

Optional 5-piece Drawer Front

Youngstown

Flat Panel

Construction:

3/4" x 2 1/4" solid wood rails with mortise and tenon corner joints

Painted finishes: composite board

Available in standard overlay only

Center panel:

1/4" veneer

Rubber balls stabilize panel and allow for wood expansion and contraction

Painted finishes: composite board

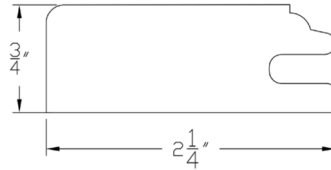

Door Profile



Standard Drawer Front

*Edge detail on drawer front matches profile.



Optional 5-piece Drawer Front

Vanderburgh

Mitered Flat Panel

Construction:

3/4" x 2 1/4" solid wood rails with mortise and tenon corner joints

Available in standard overlay only

Center panel:

1/4" veneer

Rubber balls stabilize panel and allow for wood expansion and contraction

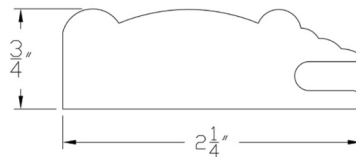

Door Profile



Standard Drawer Front



Standard Drawer Profile



Optional 5-piece Drawer Front

Kingston

Shaker

Construction:

3/4" x 2 1/4" solid wood rails with mortise and tenon corner joints

Painted finishes: composite board

Available in full overlay only

Center panel:

1/4" veneer

Rubber balls stabilize panel and allow for wood expansion and contraction

Painted finishes: composite board

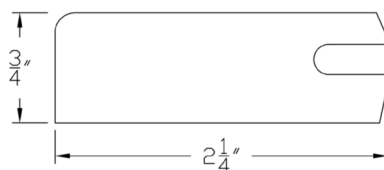

Door Profile



Standard Drawer Front

*Edge detail on drawer front matches profile.

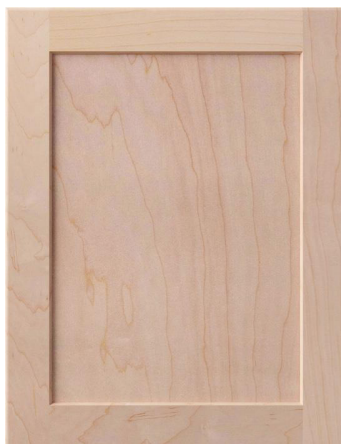

Optional 5-piece Drawer Front

Urbana

Narrow Shaker

Construction:

3/4" x 2" solid wood rails with mortise and tenon corner joints

Painted finishes: composite board

Available in full overlay only

Center panel:

1/4" veneer

Rubber balls stabilize panel and allow for wood expansion and contraction

Painted finishes: composite board

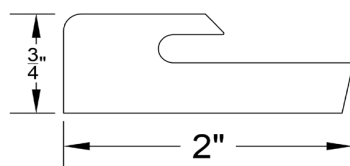

Door Profile



Standard Drawer Front

*Edge detail on drawer front matches profile.



Optional 5-piece Drawer Front

Classic

Raised Panel

Construction:

$\frac{3}{4}$ " x $2\frac{1}{4}$ " solid wood rails with mortise and tenon corner joints

Available in standard overlay only

Center panel:

$\frac{5}{8}$ " solid oak, solid cherry or maple veneer on fiberboard

Rubber balls stabilize panel and allow for wood expansion and contraction

5-piece Drawer Front:

Raised Panel: Greater than $8\frac{3}{8}$ " height

Flat Panel: Less than $8\frac{3}{8}$ " height

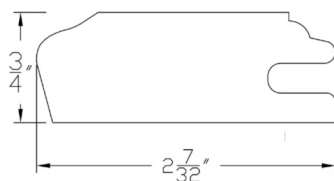

Door Profile



Standard Drawer Front

*Edge detail on drawer front matches profile.



Optional 5-piece Drawer Front

Jamestown

Wide Rail Shaker

Construction:

$\frac{3}{4}$ " x 3" solid wood rails with mortise and tenon corner joints.

Painted finishes: composite board

Available in full overlay only

Center panel:

$\frac{1}{4}$ " veneer

Rubber balls stabilize panel and allow for wood expansion and contraction.

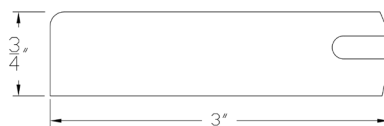

Door Profile



Standard Drawer Front

*Edge detail on drawer front matches profile.



Optional 5-piece Drawer Front

($2\frac{1}{4}$ " horizontal rail, 3" vertical rail)

Rentown

Wide Rail Flat Panel

Construction:

$\frac{3}{4}$ " x 3" solid wood rails with mortise and tenon corner joints

Painted finishes: composite board

Available in full overlay only

Center panel:

$\frac{1}{4}$ " veneer

Rubber balls stabilize panel and allow for wood expansion & contraction

Painted finishes: composite board

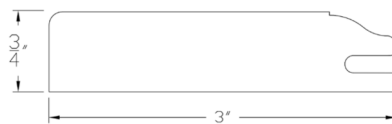

Door Profile



Standard Drawer Front
*Edge detail on drawer front matches profile.



Optional 5-piece Drawer Front
($1\frac{3}{4}$ " horizontal rail, 3" vertical rail)

Williamsburg

Mitered Raised Panel

Construction:

$\frac{3}{4}$ " x $2\frac{1}{4}$ " solid wood rails with mortise and tenon corner joints

Available in full overlay only

Center panel:

$\frac{5}{8}$ " solid wood

Rubber balls stabilize panel and allow for wood expansion and contraction

5-piece Drawer Front:

Raised Panel: Greater than $8\frac{3}{8}$ " height

Flat Panel: Less than $8\frac{3}{8}$ " height

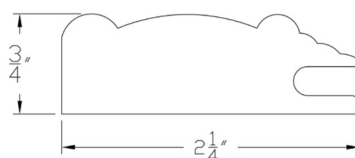

Door Profile



Standard Drawer Front



Standard Drawer Profile



Optional 5-piece Drawer Front

Mullion

Available on wall cabinets and top doors of UHC and UHB only



Available In:

- Classic
- Georgetown
- Harmony
- Jamestown
- Kingston
- Rentown
- Urbana
- Youngstown



Available In:

- Vanderburgh
- Williamsburg

Maple.....



Auburn



Coffee



Natural



Onyx



Toffee



Pecan



Slate

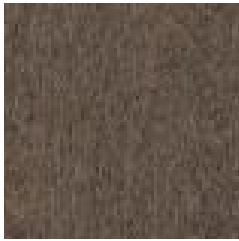

Sandstone

Painted.....



Pearl

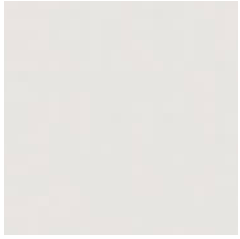

White



Limestone

Oak.....



Cobblestone

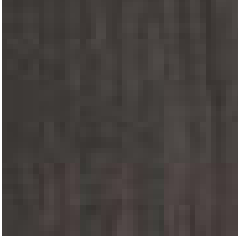

Driftwood

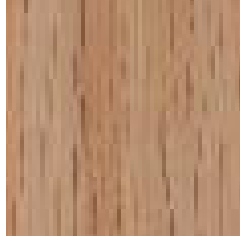

Fairfield

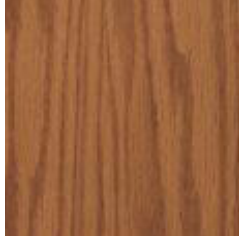

Kountry

Cherry.....

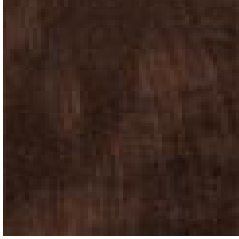

Lava

Note: Colors may not accurately be represented due to variations in the printing process. Please request a sample from your dealer.

Cabinet Dimensions

84" High Applications

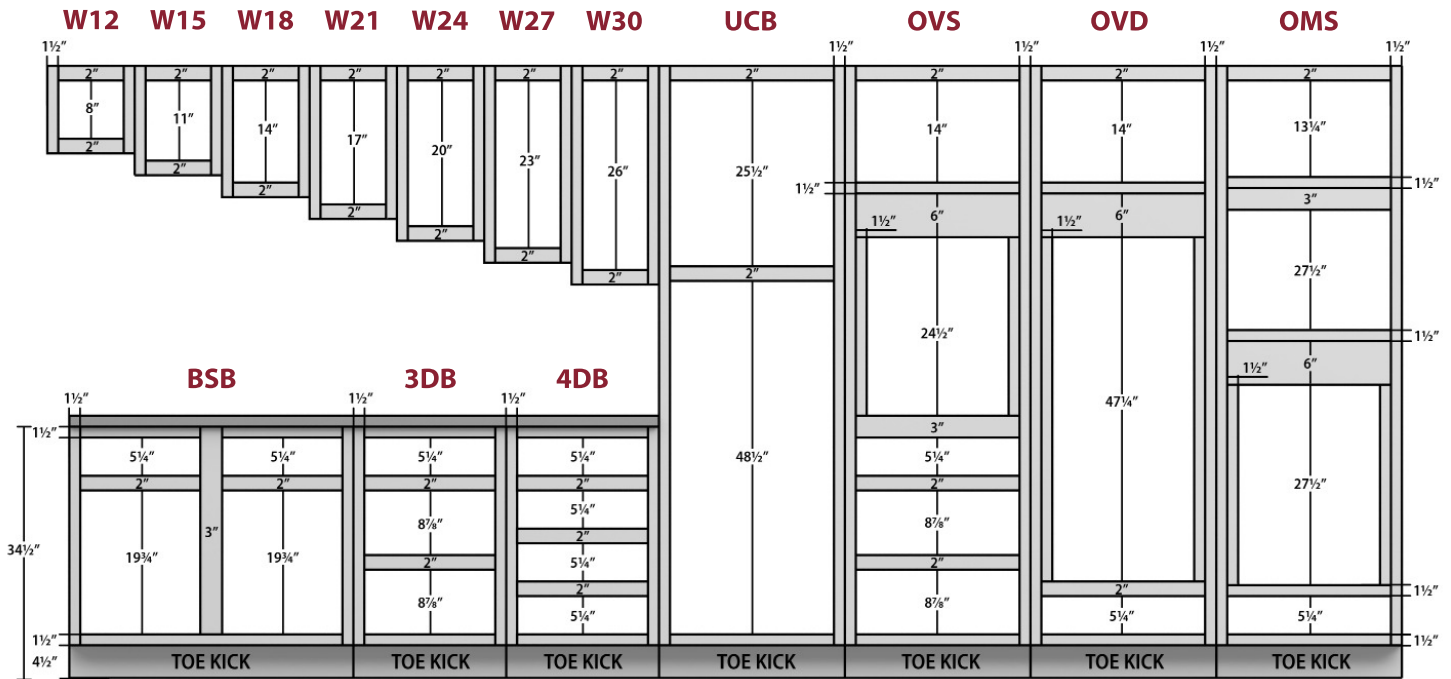

90" High Applications

96" High Applications

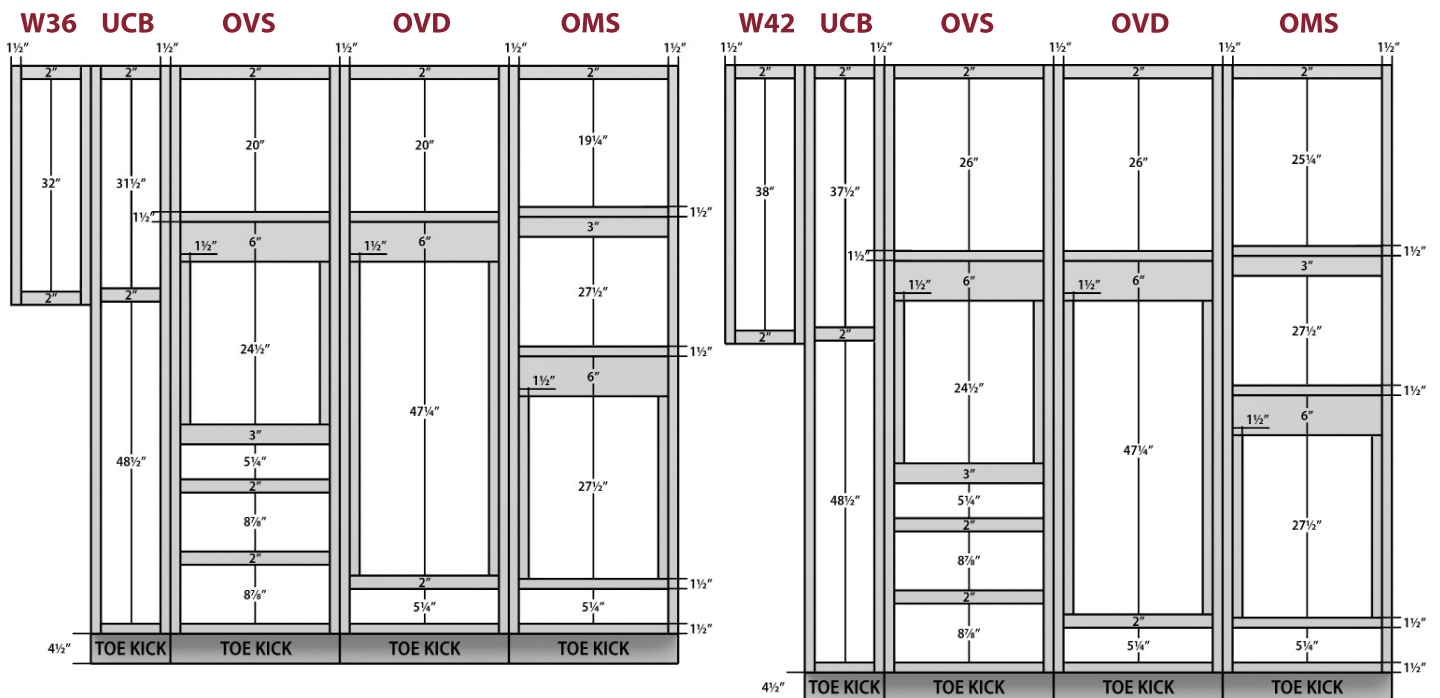

Notes

- 2" top and bottom rails - wall cabinets
- 1½" top and bottom rails - base cabinets
- 3" vertical rails divide double door cabinets 39" W and over
- Toe kick depth: 4"
- Drawer box openings are 5¼" H for standard and 8⅞" H for tall drawers
- Drawer box depth 20¾"

Vanity Cabinet Dimensions

31½" High Vanity Cabinets

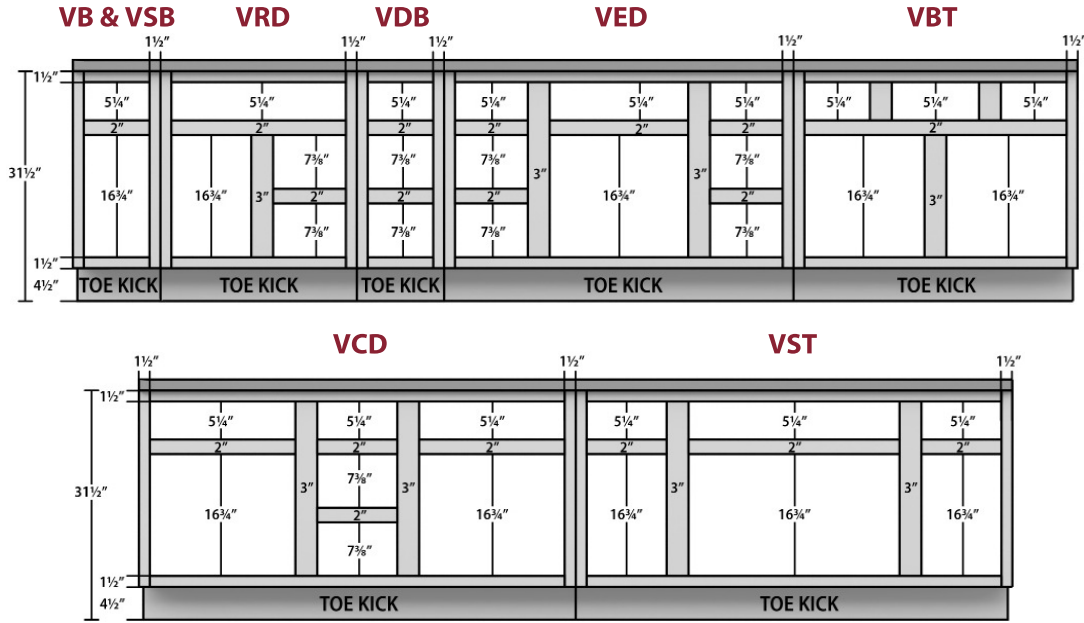

34½" High Vanity Cabinets

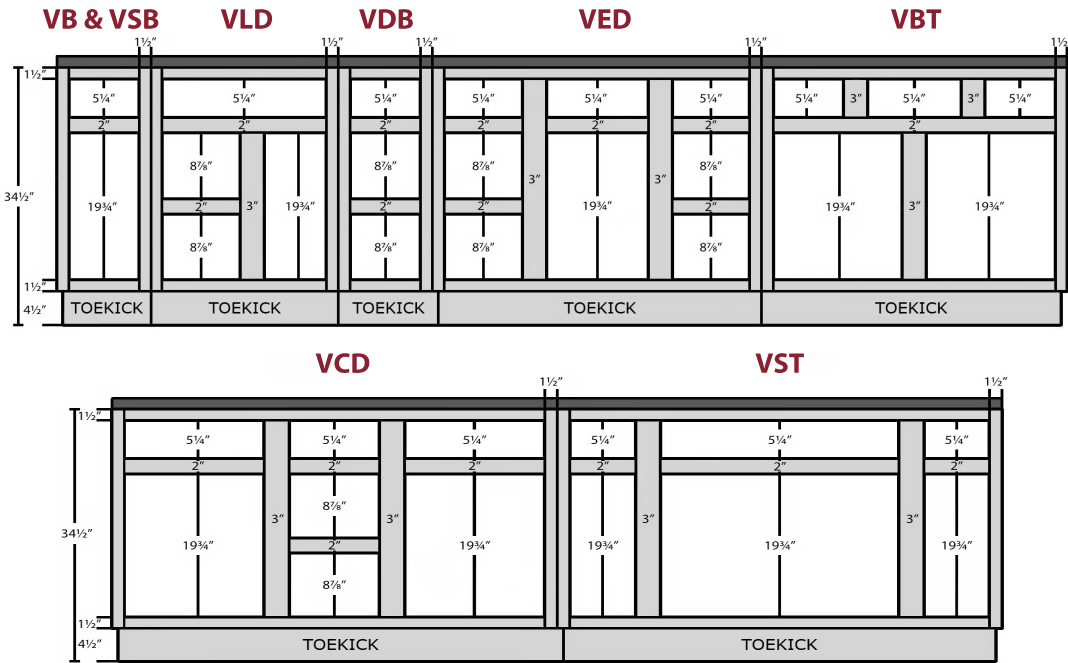

Vanity Notes

- 1½" top and bottom rails
- 3" vertical rails divide double door cabinets 39" W and over
- Toe kick depth: 3⅝"
- Drawer box openings are 5¼" H for standard and 7⅜" H for tall drawers
- 21" deep cabinets: MDF drawer box depth 16½", All Wood 18"
- 18" deep cabinets: Drawer box depth 16½"

Door Overlay Specifications

Base Cabinets

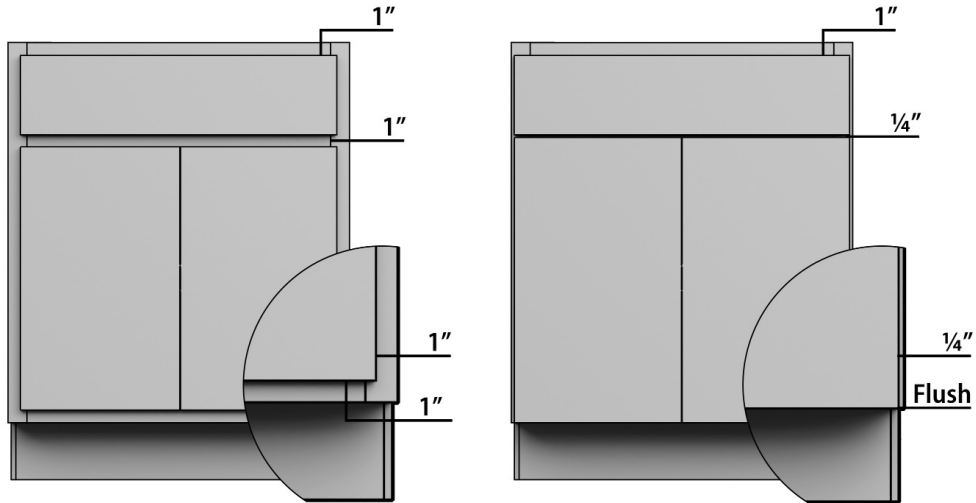

Base Cabinet Notes	
<p>Standard Overlay Door Style</p> <ul style="list-style-type: none"> • 1" reveal on sides, above, and below of door(s) • 1" reveal between door(s) and drawer front(s) 	<p>Full Overlay Door Style</p> <ul style="list-style-type: none"> • 1/4" reveal on sides of door(s) • Flush on the bottom of door(s) • 1" reveal above door(s) • 1/4" reveal between door(s) and drawer front(s)

Wall Cabinets

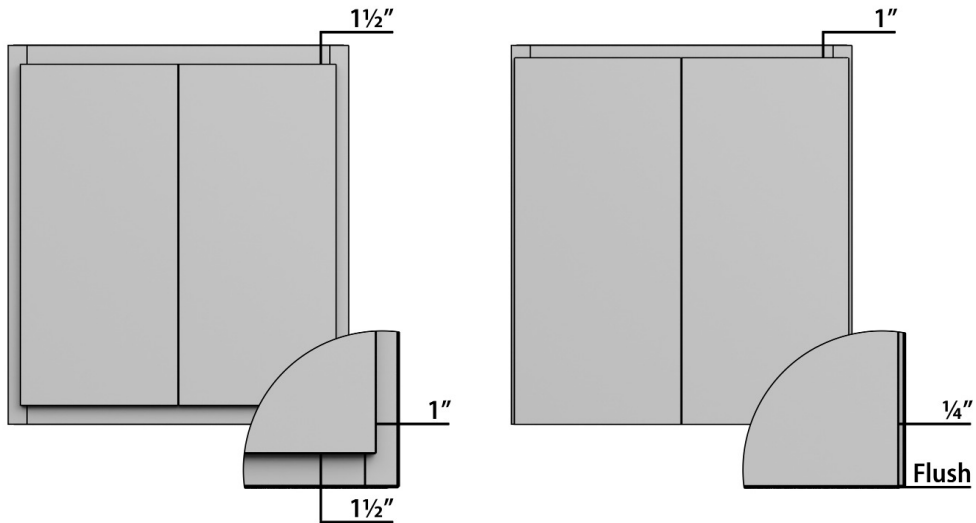

Wall Cabinet Notes	
<p>Standard Overlay Door Style</p> <ul style="list-style-type: none"> • 1" reveal on sides of door(s) • 1 1/2" reveal above and below door(s) 	<p>Full Overlay Door Style</p> <ul style="list-style-type: none"> • 1/4" reveal on sides of door(s) • Flush on the bottom of door(s) • 1" reveal on top of door(s)

Cabinet Construction Specifications

Standard and Premium

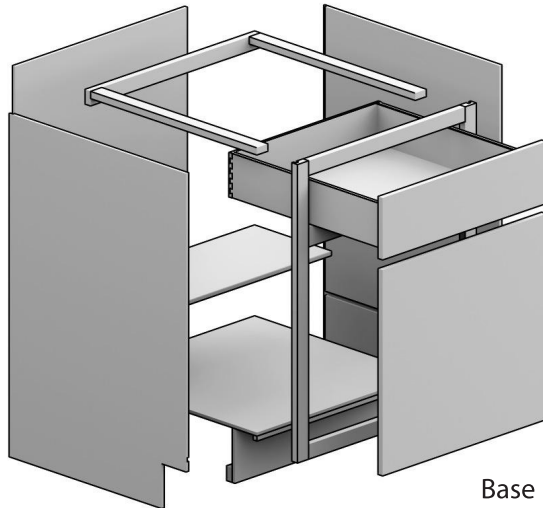

Base

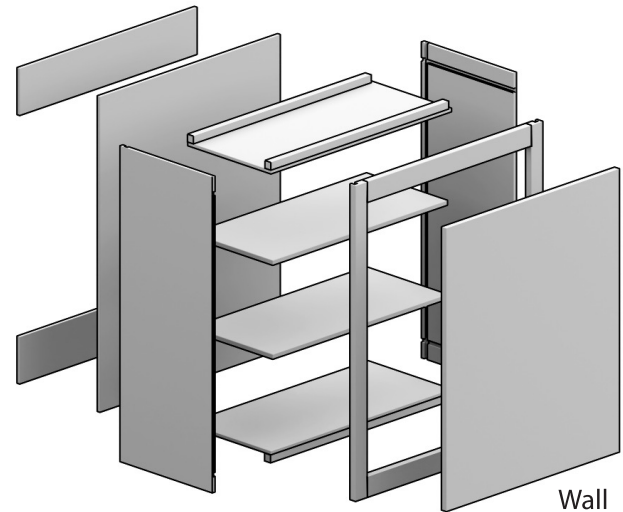

Wall

Construction Notes

Cabinet Fronts

- $\frac{3}{4}$ " solid wood
- Front stiles are pocket drilled and assembled with $1\frac{1}{4}$ " screws for durability

Side Panels

- $\frac{3}{8}$ " particle board (**Premium option: $\frac{3}{8}$ " plywood**)
- Vinyl covered on both sides
- Glued and stapled in a $\frac{3}{8}$ " dado in the cabinet's front frame

Back Panels

- $\frac{3}{8}$ " particle board (**Premium option: $\frac{3}{8}$ " plywood**)
- Vinyl covered on inside ONLY
- Glued and nailed in $\frac{3}{8}$ " dado and stapled to the hang rail and cabinet bottom

Top (Wall only) and Floor Panels

- $\frac{3}{8}$ " particle board (**Premium option: $\frac{3}{8}$ " plywood**)
- Vinyl covered on inside ONLY

Backer Rails (Wall Only)

- Particle board (**Premium option: plywood**)
- Installed at both the top and bottom of the cabinet

Hanging Rails (Base Only)

- $\frac{3}{4}$ " x $1\frac{1}{2}$ " all wood
- Installed on sides and back

Shelves (Wall Only)

- Adjustable $\frac{1}{2}$ " MDF (**Premium option: adjustable $\frac{1}{2}$ " plywood**)
- Bullnose, foil-covered front edges
- Shelves are held in place with self-locking clips on the sides and center stile (if applicable)

Shelves (Base Only)

- Fixed $\frac{1}{2}$ " MDF (**Premium option: fixed $\frac{1}{2}$ " plywood**)
- Bullnose, foil-covered front edges

Toe Kick (Base Only)

NOTE: Vanity measurements include applied toe kick cover

- Standard Base: $4\frac{1}{2}$ " high x 4" D;
- Vanity Base $4\frac{1}{2}$ " high x $3\frac{5}{8}$ " D

Drawers (Base Only)

- $\frac{1}{2}$ " MDF **NOTE: Cabinets 27" - 36" W use $\frac{1}{2}$ " finished solid wood** (**Premium option: $\frac{1}{2}$ " finished solid wood**)
- Bullnose, foil-covered top edges
- Dovetail construction standard
- Drawers glide on self-adjusting ball bearing nylon guides



Doors

- Door Construction Specifications are on pages 8 - 14
- Butt Doors: Available on 24" W Cabinets, Standard on 27" - 36" W
- Hidden, self-closing adjustable hinge

Finish

- All cabinet front and door surfaces receive stain and a catalyzed clear or a catalyzed paint finish. Our finish provides a deep, rich wood tone that is resistant to household chemicals, water, food stains and mild acids.

Optional Construction Features

- See page 5 for option details

Wall Cabinets

Wall Cabinets 12" - 42" High

- Two hinges per door 12-30" high, 3 hinges per door 36-42" high
- No shelf 12-21" high, one shelf 24" high, two adjustable shelves 27-30" high, 3 adjustable shelves 36-42" high
- For one door cabinets, turn cabinet 180 degrees upon install for preferred L or R door opening
- Butt door option available on cabinet 24" W
- Butt doors standard on cabinets 27"-36" W
- Two doors with center stile on cabinets 39"-48" W
- Premium all wood package upgrade available
- Soft close hinge upgrade available, see page 5

Single Door 9 - 24 W

Butt Door (24) 27 - 36 W

Center Stile 39 - 48 W

9 - 48 W
12 - 42 H
12 - 24 D

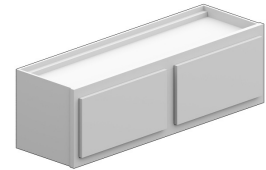
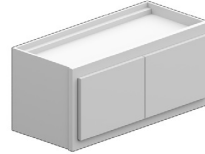

12" - 42" High x 12" - 15" Deep

NOTE: For 15" deep cabinets add 15 to the end of the model number and change the final 12 on the item number to 15

12" High		15" High		18" High		21" High	
MODEL NUMBER	ITEM NUMBER	MODEL NUMBER	ITEM NUMBER	MODEL NUMBER	ITEM NUMBER	MODEL NUMBER	ITEM NUMBER
W1212	WAL121212	W1215	WAL121512	W1218	WAL121812	W1221	WAL122112
W1512	WAL151212	W1515	WAL151512	W1518	WAL151812	W1521	WAL152112
W1812	WAL181212	W1815	WAL181512	W1818	WAL181812	W1821	WAL182112
W2112	WAL211212	W2115	WAL211512	W2118	WAL211812	W2121	WAL212112
W2412	WAL241212	W2415	WAL241512	W2418	WAL241812	W2421	WAL242112
W2712	WAL271212	W2715	WAL271512	W2718	WAL271812	W2721	WAL272112
W3012	WAL301212	W3015	WAL301512	W3018	WAL301812	W3021	WAL302112
W3312	WAL331212	W3315	WAL331512	W3318	WAL331812	W3321	WAL332112
W3612	WAL361212	W3615	WAL361512	W3618	WAL361812	W3621	WAL362112
W3912	WAL391212	W3915	WAL391512	W3918	WAL391812		
W4212	WAL421212	W4215	WAL421512	W4218	WAL421812		
W4812	WAL481212	W4815	WAL481512	W4518	WAL451812		
				W4818	WAL481812		
24" High		27" High		30" High		36" High	
MODEL NUMBER	ITEM NUMBER	MODEL NUMBER	ITEM NUMBER	MODEL NUMBER	ITEM NUMBER	MODEL NUMBER	ITEM NUMBER
W1224	WAL122412	W2427	WAL242712	W0930	WAL093012	W0936	WAL093612
W1524	WAL152412	W3027	WAL302712	W1230	WAL123012	W1236	WAL123612
W1824	WAL182412	W3327	WAL332712	W1530	WAL153012	W1536	WAL153612
W2124	WAL212412	W3627	WAL362712	W1830	WAL183012	W1836	WAL183612
W2424	WAL242412	W3927	WAL392712	W2130	WAL213012	W2136	WAL213612
W2724	WAL272412	W4227	WAL422712	W2430	WAL243012	W2436	WAL243612
W3024	WAL302412	W4527	WAL452712	W2730	WAL273012	W2736	WAL273612
W3324	WAL332412	W4827	WAL482712	W3030	WAL303012	W3036	WAL303612
W3624	WAL362412			W3330	WAL333012	W3336	WAL333612
W3924	WAL392412			W3630	WAL363012	W3636	WAL363612
W4224	WAL422412			W3930	WAL393012	W3936	WAL393612
W4524	WAL452412			W4230	WAL423012	W4236	WAL423612
W4824	WAL482412			W4530	WAL453012	W4536	WAL453612
				W4830	WAL483012	W4836	WAL483612
42" High							
MODEL NUMBER	ITEM NUMBER	MODEL NUMBER	ITEM NUMBER	MODEL NUMBER	ITEM NUMBER	MODEL NUMBER	ITEM NUMBER
W0942	WAL094212	W2142	WAL214212	W3342	WAL334212	W4542	WAL454212
W1242	WAL124212	W2442	WAL244212	W3642	WAL364212	W4842	WAL484212
W1542	WAL154212	W2742	WAL274212	W3942	WAL394212		
W1842	WAL184212	W3042	WAL304212	W4242	WAL424212		

All shelves and bottoms are rated to withstand 15 lbs. per square foot.

Peninsula Option
Model Number: Replace W with PW
Item Number: Replace WAL with WPE

For additional cabinet options, please see page 5.

Wall Cabinets

15" - 42" x 18" Deep

15" High		24 & 30" High		36" High		42" High	
MODEL NUMBER	ITEM NUMBER	MODEL NUMBER	ITEM NUMBER	MODEL NUMBER	ITEM NUMBER	MODEL NUMBER	ITEM NUMBER
W271518	WAL271518	W302418	WAL302418	W153618	WAL153618	W124218	WAL124218
W331518	WAL331518	30"	30"	W363618	WAL363618	W184218	WAL184218
W361518	WAL361518	W213018	WAL213018	W423618	WAL423618	W274218	WAL274218
W391518	WAL391518	W243018	WAL243018			W304218	WAL304218
W421518	WAL421518	W363018	WAL363018			W364218	WAL364218
W481518	WAL481518						

12" - 42" x 24" Deep

12" High		15" High		18" High		21" High	
MODEL NUMBER	ITEM NUMBER	MODEL NUMBER	ITEM NUMBER	MODEL NUMBER	ITEM NUMBER	MODEL NUMBER	ITEM NUMBER
W121224	WAL121224	W121524	WAL121524	W121824	WAL121824	W122124	WAL122124
W151224	WAL151224	W151524	WAL151524	W151824	WAL151824	W152124	WAL152124
W271224	WAL271224	W181524	WAL181524	W241824	WAL241824	W182124	WAL182124
W301224	WAL301224	W211524	WAL211524	W301824	WAL301824	W212124	WAL212124
W331224	WAL331224	W241524	WAL241524	W331824	WAL331824	W242124	WAL242124
W361224	WAL361224	W271524	WAL271524	W361824	WAL361824	W362124	WAL362124
W391224	WAL391224	W301524	WAL301524	W391824	WAL391824		
W421224	WAL421224	W331524	WAL331524	W421824	WAL421824		
W481224	WAL481224	W361524	WAL361524	W451824	WAL451824		
		W391524	WAL391524	W481824	WAL481824		
		W421524	WAL421524				
		W481524	WAL481524				

24" High

30" High

42" High

MODEL NUMBER	ITEM NUMBER	MODEL NUMBER	ITEM NUMBER	MODEL NUMBER	ITEM NUMBER		
W122424	WAL122424	W093024	WAL093024	W094224	WAL094224		
W152424	WAL152424	W123024	WAL123024	W124224	WAL124224		
W182424	WAL182424	W153024	WAL153024	W154224	WAL154224		
W212424	WAL212424	W183024	WAL183024	W184224	WAL184224		
W242424	WAL242424	W213024	WAL213024	W214224	WAL214224		
W272424	WAL272424	W243024	WAL243024	W244224	WAL244224		
W302424	WAL302424	W273024	WAL273024	W274224	WAL274224		
W332424	WAL332424	W303024	WAL303024	W304224	WAL304224		
W362424	WAL362424	W333024	WAL333024	W334224	WAL334224		
W392424	WAL392424	W363024	WAL363024	W364224	WAL364224		
W422424	WAL422424	W393024	WAL393024	W394224	WAL394224		
W452424	WAL452424	W423024	WAL423024	W424224	WAL424224		
W482424	WAL482424	W453024	WAL453024	W454224	WAL454224		
		W483024	WAL483024	W484224	WAL484224		

All shelves and bottoms are rated to withstand 15 lbs. per square foot.

Peninsula Option

Model Number: Replace W with PW
Item Number: Replace WAL with WPE

For additional cabinet options, please see page 5.

Wall Cabinets

Starter Wall Cabinets

54, 60, 72 W
30 H
12 D

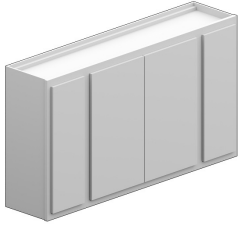

- Four doors; center butt doors
- Two hinges per door
- Two adjustable shelves
- Soft close hinge upgrade available, see page 5
- Premium all wood package upgrade available

MODEL NUMBER

STW5430
STW6030
STW7230

ITEM NUMBER

WST543012
WST603012
WST723012

Starter U Wall Cabinets

54, 60, 72 W
30 H
12 D

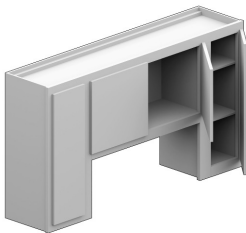

Center Cabinet:
30 W x 18 H

- Four doors; center butt doors
- Two hinges per door
- Two adjustable shelves
- Soft close hinge upgrade available, see page 5
- Premium all wood package upgrade available

MODEL NUMBER

STU5430
STU6030
STU7230

ITEM NUMBER

WSU543012
WSU603012
WSU723012

Wall Microwave Cabinets

Microwave Opening:
30 H x 12 or 21 D -
27 W x 16 H

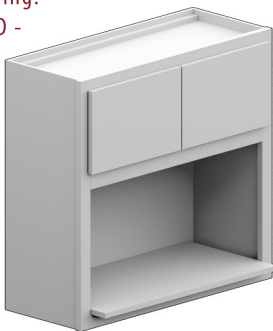

36 or 42 H x
12 or 21 D -
27 W x 18 H

- Butt doors
- Two hinges per door
- Soft close hinge upgrade available, see page 5
- 30" and 36" H: no shelf
- Available in 12" or 21" depth
- Bottom Shelf: 14" or 23" D
- Matching interior option recommended

MODEL NUMBER

WMW273012
WMW273612
WMW274212
WMW273021
WMW273621
WMW274221
WMW3030
WMW3036
WMW3042
WMW303021
WMW303621
WMW304221

ITEM NUMBER

WMW273012
WMW273612
WMW274212
WMW273021
WMW273621
WMW274221
WMW303012
WMW303612
WMW304212
WMW303021
WMW303621
WMW304221

Wall Plate Rack

30 W
18 H
12 or 15 D

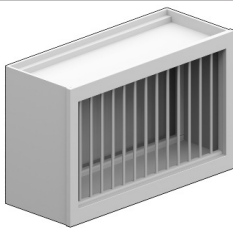

- No doors
- No shelves
- 12" or 15" depth available
- Matching interior included
- 14 plate capacity

MODEL NUMBER

PR301812
PR301815

ITEM NUMBER

WPR301812
WPR301815

Wall Wine Cabinet

30 W
15 H
12 or 15 D

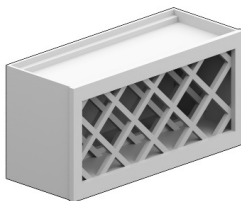

- No doors
- No shelves
- 12" or 15" depth available
- Matching interior included
- 11 bottle capacity

MODEL NUMBER

WR301512
WR301515

ITEM NUMBER

WWR301512
WWR301515

All shelves and bottoms are rated to withstand 15 lbs. per square foot.

For additional cabinet options, please see page 5.

Wall Cabinets

Wall Angle Cabinets

30, 36, 42 H Backs: 12 	<ul style="list-style-type: none"> • One door; L or R door hinging available • Soft close hinge upgrade available, see page 5 • Two hinges per door on 30" H • Three hinges per door on 36" and 42" H • Two shelves in 30" H • Three shelves in 36" and 42" H • Premium all wood package upgrade available 	MODEL NUMBER	ITEM NUMBER
		WAC123012	WAC123012
		WAC123612	WAC123612
		WAC124212	WAC124212

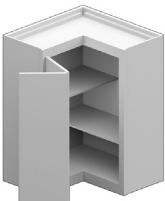

Wall Easy Reach Cabinets

24, 30, 36, 42 Backs: 24 	<ul style="list-style-type: none"> • Easy reach door; L or R hinging available • Two hinges per door on 24" and 30" H • Three hinges per door on 36" and 42" H • No shelves in 24" H • Two shelves in 30" H • Three shelves in 36" and 42" H • Premium all wood package upgrade available 	MODEL NUMBER	ITEM NUMBER
		WER2424	WER242424
		WER2430	WER243024
		WER2436	WER243624
		WER2442	WER244224

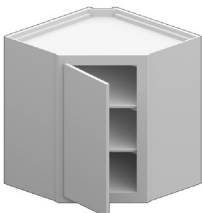
Diagonal Wall Corner Cabinets 24" x 24", 27" x 27"

12 - 42 H Backs: 24 Ends: 12 	<ul style="list-style-type: none"> • One door; L or R door hinging available • Two hinges per door on 24" and 30" H • Three hinges per door on 36" and 42" H • Soft close hinge upgrade available, see page 5 	<ul style="list-style-type: none"> • No shelves in 12" - 24" H • Two adjustable shelves in 30" H • Three adjustable shelves in 36" and 42" H • Premium all wood package upgrade available 																																															
		<table border="1"> <thead> <tr> <th>Standard Overlay Door Size</th> <th>Full Overlay Door Size</th> <th>MODEL NUMBER</th> <th>ITEM NUMBER</th> </tr> </thead> <tbody> <tr><td>14" x 9" - 12 H</td><td>14" x 11" - 12 H</td><td>DWC2412</td><td>WDC241224</td></tr> <tr><td>14" x 12" - 15 H</td><td>14" x 14" - 15 H</td><td>DWC2415</td><td>WDC241524</td></tr> <tr><td>14" x 15" - 18 H</td><td>14" x 17" - 18 H</td><td>DWC2418</td><td>WDC241824</td></tr> <tr><td>14" x 18" - 21 H</td><td>14" x 20" - 21 H</td><td>DWC2421</td><td>WDC242124</td></tr> <tr><td>14" x 21" - 24 H</td><td>14" x 23" - 24 H</td><td>DWC2424</td><td>WDC242424</td></tr> <tr><td>14" x 27" - 30 H</td><td>14" x 29" - 30 H</td><td>DWC2430</td><td>WDC243024</td></tr> <tr><td>14" x 33" - 36 H</td><td>14" x 35" - 36 H</td><td>DWC2436</td><td>WDC243624</td></tr> <tr><td>14" x 39" - 42 H</td><td>14" x 41" - 42 H</td><td>DWC2442</td><td>WDC244224</td></tr> <tr><td>14" x 27" - 30 H</td><td>14" x 29" - 30 H</td><td>DWC2730</td><td>WDC273027</td></tr> <tr><td>14" x 33" - 36 H</td><td>14" x 35" - 36 H</td><td>DWC2736</td><td>WDC273627</td></tr> <tr><td>14" x 39" - 42 H</td><td>14" x 41" - 42 H</td><td>DWC2742</td><td>WDC274227</td></tr> </tbody> </table>	Standard Overlay Door Size	Full Overlay Door Size	MODEL NUMBER	ITEM NUMBER	14" x 9" - 12 H	14" x 11" - 12 H	DWC2412	WDC241224	14" x 12" - 15 H	14" x 14" - 15 H	DWC2415	WDC241524	14" x 15" - 18 H	14" x 17" - 18 H	DWC2418	WDC241824	14" x 18" - 21 H	14" x 20" - 21 H	DWC2421	WDC242124	14" x 21" - 24 H	14" x 23" - 24 H	DWC2424	WDC242424	14" x 27" - 30 H	14" x 29" - 30 H	DWC2430	WDC243024	14" x 33" - 36 H	14" x 35" - 36 H	DWC2436	WDC243624	14" x 39" - 42 H	14" x 41" - 42 H	DWC2442	WDC244224	14" x 27" - 30 H	14" x 29" - 30 H	DWC2730	WDC273027	14" x 33" - 36 H	14" x 35" - 36 H	DWC2736	WDC273627	14" x 39" - 42 H	14" x 41" - 42 H	DWC2742
Standard Overlay Door Size	Full Overlay Door Size	MODEL NUMBER	ITEM NUMBER																																														
14" x 9" - 12 H	14" x 11" - 12 H	DWC2412	WDC241224																																														
14" x 12" - 15 H	14" x 14" - 15 H	DWC2415	WDC241524																																														
14" x 15" - 18 H	14" x 17" - 18 H	DWC2418	WDC241824																																														
14" x 18" - 21 H	14" x 20" - 21 H	DWC2421	WDC242124																																														
14" x 21" - 24 H	14" x 23" - 24 H	DWC2424	WDC242424																																														
14" x 27" - 30 H	14" x 29" - 30 H	DWC2430	WDC243024																																														
14" x 33" - 36 H	14" x 35" - 36 H	DWC2436	WDC243624																																														
14" x 39" - 42 H	14" x 41" - 42 H	DWC2442	WDC244224																																														
14" x 27" - 30 H	14" x 29" - 30 H	DWC2730	WDC273027																																														
14" x 33" - 36 H	14" x 35" - 36 H	DWC2736	WDC273627																																														
14" x 39" - 42 H	14" x 41" - 42 H	DWC2742	WDC274227																																														
30, 36, 42 H Backs: 27 Ends: 15 																																																	

Diagonal Wall Lazy Susan Cabinets 24" x 24", 27" x 27"

30, 36, 42 H Backs: 24 Ends: 12 	<ul style="list-style-type: none"> • One door; L or R door hinging available • Two hinges per door on 30" H • Three hinges per door on 36" and 42" H • Soft close hinge upgrade available, see page 5 	<ul style="list-style-type: none"> • Two trays; wooden tray upgrade available • Tray weight capacity: 75 lbs • Tray dimensions: 18" diameter • Premium all wood package upgrade available 																											
		<table border="1"> <thead> <tr> <th>Standard Overlay Door Size</th> <th>Full Overlay Door Size</th> <th>MODEL NUMBER</th> <th>ITEM NUMBER</th> </tr> </thead> <tbody> <tr><td>14" x 27" - 30 H</td><td>14" x 29" - 30 H</td><td>WLZ2430</td><td>WLZ243024</td></tr> <tr><td>14" x 33" - 36 H</td><td>14" x 35" - 36 H</td><td>WLZ2436</td><td>WLZ243624</td></tr> <tr><td>14" x 39" - 42 H</td><td>14" x 41" - 42 H</td><td>WLZ2442</td><td>WLZ244224</td></tr> <tr><td>14" x 27" - 30 H</td><td>14" x 29" - 30 H</td><td>WLZ2430</td><td>WLZ273027</td></tr> <tr><td>14" x 33" - 36 H</td><td>14" x 35" - 36 H</td><td>WLZ2436</td><td>WLZ273627</td></tr> <tr><td>14" x 39" - 42 H</td><td>14" x 41" - 42 H</td><td>WLZ2442</td><td>WLZ274227</td></tr> </tbody> </table>	Standard Overlay Door Size	Full Overlay Door Size	MODEL NUMBER	ITEM NUMBER	14" x 27" - 30 H	14" x 29" - 30 H	WLZ2430	WLZ243024	14" x 33" - 36 H	14" x 35" - 36 H	WLZ2436	WLZ243624	14" x 39" - 42 H	14" x 41" - 42 H	WLZ2442	WLZ244224	14" x 27" - 30 H	14" x 29" - 30 H	WLZ2430	WLZ273027	14" x 33" - 36 H	14" x 35" - 36 H	WLZ2436	WLZ273627	14" x 39" - 42 H	14" x 41" - 42 H	WLZ2442
Standard Overlay Door Size	Full Overlay Door Size	MODEL NUMBER	ITEM NUMBER																										
14" x 27" - 30 H	14" x 29" - 30 H	WLZ2430	WLZ243024																										
14" x 33" - 36 H	14" x 35" - 36 H	WLZ2436	WLZ243624																										
14" x 39" - 42 H	14" x 41" - 42 H	WLZ2442	WLZ244224																										
14" x 27" - 30 H	14" x 29" - 30 H	WLZ2430	WLZ273027																										
14" x 33" - 36 H	14" x 35" - 36 H	WLZ2436	WLZ273627																										
14" x 39" - 42 H	14" x 41" - 42 H	WLZ2442	WLZ274227																										
30, 36, 42 H Backs: 27 Ends: 15 																													

All shelves and bottoms are rated to withstand 15 lbs. per square foot.

For additional cabinet options, please see page 5.

Blind Wall Cabinets



Blind Corner Wall Cabinets 30" High				Blind Corner Wall Cabinets 36" or 42" High																									
24-48 W 30 H 12 D 		<ul style="list-style-type: none"> • One door on cabinets 24"-36" W • Butt doors on cabinets 39"-48" W • Two hinges per door • Two adjustable shelves • Specify Left or Right blind • Premium all wood package upgrade available • Soft close hinge upgrade available, see page 5 • Please reference drawings below for (A), (B), (C), (D) cabinet measurements 		24-48 W 36 or 42 H 12 D 		<ul style="list-style-type: none"> • One door on cabinets 24"-36" W, butt doors on cabinets 39"-48" W • Three hinges per door • Three adjustable shelves • Specify Left or Right blind • Premium all wood package upgrade available. • Soft close hinge upgrade available, see page 5 • Please reference drawings below for (A), (B), (C), (D) cabinet measurements 																							
30" High		36" High		42" High																									
MODEL NUMBER	ITEM NUMBER	MODEL NUMBER	ITEM NUMBER	MODEL NUMBER	ITEM NUMBER	(A)	(B)	(C)	(D)	<table border="1"> <thead> <tr> <th colspan="4">Door Hardware Clearance</th> </tr> <tr> <th colspan="2">F/O</th> <th colspan="2">S/O</th> </tr> <tr> <th>Min. Pull</th> <th>Max. Pull</th> <th>Min. Pull</th> <th>Max. Pull</th> </tr> </thead> <tbody> <tr> <td>1/8</td> <td>3 1/16</td> <td>13/16</td> <td>3 3/4</td> </tr> </tbody> </table>				Door Hardware Clearance				F/O		S/O		Min. Pull	Max. Pull	Min. Pull	Max. Pull	1/8	3 1/16	13/16	3 3/4
Door Hardware Clearance																													
F/O		S/O																											
Min. Pull	Max. Pull	Min. Pull	Max. Pull																										
1/8	3 1/16	13/16	3 3/4																										
WC24-2730	WCC243012	WC24-2736	WCC243612	WC24-2742	WCC244212	24	24	27	25																				
WC27-3030	WCC273012	WC27-3036	WCC273612	WC27-3042	WCC274212	27	27	30	28																				
WC30-3330	WCC303012	WC30-3336	WCC303612	WC30-3342	WCC304212	30	30	33	31																				
WC33-3630	WCC333012	WC33-3636	WCC333612	WC33-3642	WCC334212	33	33	36	34																				
WC36-3930	WCC363012	WC36-3936	WCC363612	WC36-3942	WCC364212	36	36	39	37																				
WC39-4230	WCC393012	WC39-4236	WCC393612	WC39-4242	WCC394212	39	39	42	40																				
WC42-4530	WCC423012	WC42-4536	WCC423612	WC42-4542	WCC424212	42	42	45	43																				
WC45-4830	WCC453012	WC45-4836	WCC453612	WC45-4842	WCC454212	45	45	48	46																				
WC48-5130	WCC483012	WC48-5136	WCC483612	WC48-5142	WCC484212	48	48	51	49																				

Illustration - Wall Cabinets

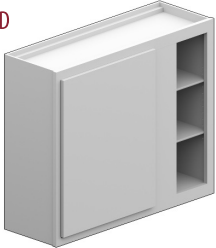

All shelves and bottoms are rated to withstand 15 lbs. per square foot.

For additional cabinet options, please see page 5.

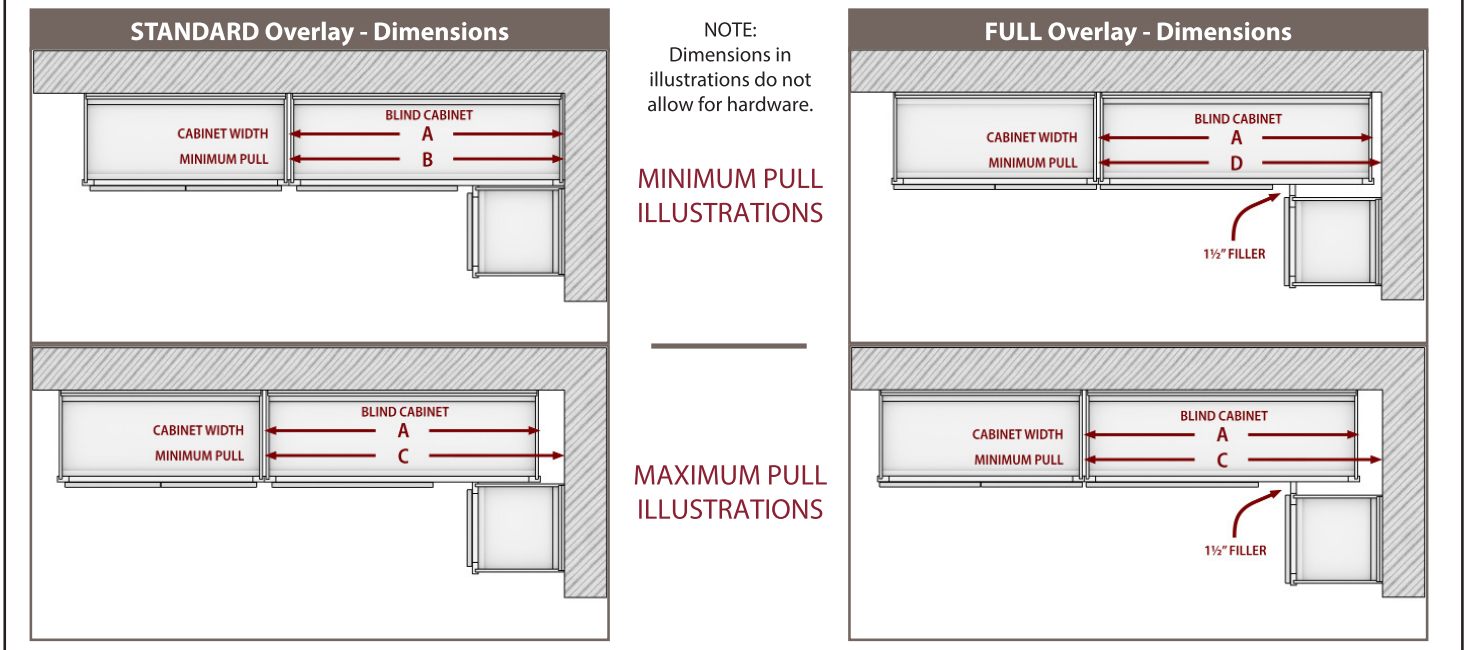
Base Cabinets

3-Drawer Bank Cabinets

12 - 36 W
34½ H
24 D



- Three drawers
- Drawer weight capacity: 75 lbs
- Dovetail drawers standard
- Soft close, full extension drawer upgrade available, see page 5
- Premium all wood package upgrade available

MODEL NUMBER
3DB12
3DB15
3DB18
3DB21
3DB24
3DB27
3DB30

ITEM NUMBER
B3D122434
B3D152434
B3D182434
B3D212434
B3D242434
B3D272434
B3D302434

MODEL NUMBER
3DB33
3DB36

ITEM NUMBER
B3D332434
B3D362434

4-Drawer Bank Cabinets

12 - 24 W
34½ H
24 D



- Four drawers
- Drawer weight capacity: 75 lbs
- Dovetail drawers standard
- Soft close, full extension drawer upgrade available, see page 5
- Premium all wood package upgrade available

MODEL NUMBER
4DB12
4DB15
4DB18
4DB21
4DB24

ITEM NUMBER
B4D122434
B4D152434
B4D182434
B4D212434
B4D242434

Base Cabinets 12" - 48" Wide

- Single door standard on cabinets 12-24 W, butt doors optional on cabinet 24" W
- Butt doors standard on cabinets 27-36 W
- Two doors on cabinets 39-48 W

- Two hinges per door
- One fixed shelf
- One drawer on cabinets 12-36 W
- Two drawers on cabinets 39-48 W

- Drawer weight capacity: 75 lbs
- Dovetail drawers standard. Note: 27"-36" W include wood drawers
- Soft close hinge and drawer upgrade available, see page 5
- Premium all wood package upgrade available

Single Door 12-24 W

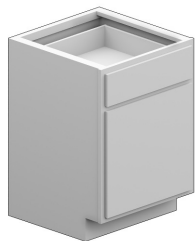

Butt Door (24) 27-36 W

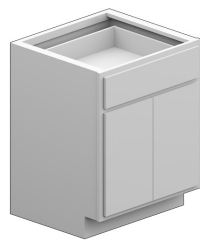

Center Stile 39-48 W

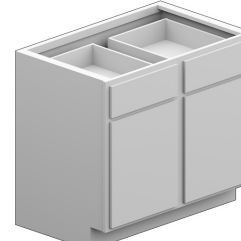

12 - 48 W
34½ H
24 D

12" - 24" Wide

MODEL NUMBER
B12
B15
B18
B21
B24

ITEM NUMBER
BAS122434
BAS152434
BAS182434
BAS212434
BAS242434

27" - 36" Wide

MODEL NUMBER
B27
B30
B33
B36

ITEM NUMBER
BAS272434
BAS302434
BAS332434
BAS362434

39" - 48" Wide

MODEL NUMBER
B39
B42
B45
B48

ITEM NUMBER
BAS392434
BAS422434
BAS452434
BAS482434

Base Starter Cabinets

34½ H
54, 60, 72 W
24 D

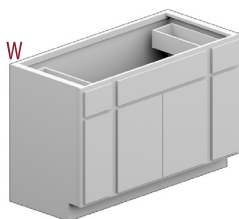

- Four doors, center butt doors
- Two hinges per door
- One Fixed Shelf
- Two drawers
- Drawer weight capacity: 75 lbs
- Dovetail drawers standard
- Soft close hinge and drawer upgrade available, see page 5
- Premium all wood package upgrade available

MODEL NUMBER
STB54
STB60
STB72

ITEM NUMBER
BST542434
BST602434
BST722434

All shelves and bottoms are rated to withstand 15 lbs. per square foot.

Peninsula Option

Model Number: Replace B with PB
Item Number: Replace BAS with BPE

For additional cabinet options, please see page 5.

Base Cabinets

Range and Sink Bases 24" - 48" Wide

- Single door standard, butt doors optional on 24" W
- Two hinges per door
- Premium all wood package upgrade available
- Butt doors standard on cabinets 27"-36" W
- Soft close hinge upgrade available, see page 5
- Peninsula option available; specify BPS instead of BSB
- Two doors on cabinets 39"-48" W
- No drawers
- Farmhouse sink (BFS) on 27"-48" W

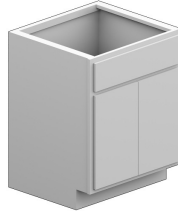
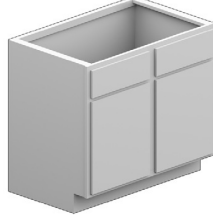
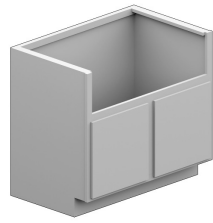
<p>Single Door 24 W</p>  <p>24 - 48 W 34½ H 24 D</p>	<p>Butt Door (24) 27-36 W</p> 	<p>Center Stile 39-48 W</p> 	<p>(BFS) Farmhouse Sink Option</p>  <p>(27-48 W, 39 W shown)</p>
---	---	--	---

STANDARD RANGE AND SINK BASE

MODEL NUMBER	ITEM NUMBER	MODEL NUMBER	ITEM NUMBER	MODEL NUMBER	ITEM NUMBER
SB24	BSB242434	SB33	BSB332434	SB42	BSB422434
SB27	BSB272434	SB36	BSB362434	SB45	BSB452434
SB30	BSB302434	SB39	BSB392434	SB48	BSB482434

FARMHOUSE SINK OPTION		OPENING SIZE		MAX TRIMMABLE OPENING SIZE	
MODEL NUMBER	ITEM NUMBER	AS BUILT WIDTH	AS BUILT HEIGHT	MAX WIDTH	MAX HEIGHT
FSB27	BFS272434	24	8.75	25	9.75
FSB30	BFS302434	27	8.75	28	9.75
FSB33	BFS332434	30	8.75	31	9.75
FSB36	BFS362434	33	8.75	34	9.75
FSB39	BFS392434	36	8.75	37	9.75
FSB42	BFS422434	39	8.75	40	9.75
FSB45	BFS452434	42	8.75	43	9.75
FSB48	BFS482434	45	8.75	46	9.75

Diagonal Sink Bases

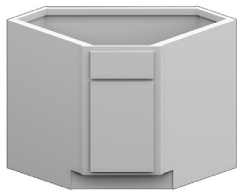
<p>34½ H 42x42 or 36x36</p>  <p>BDI - Cab Front & Floor • BDC - Complete (shown)</p>	<ul style="list-style-type: none"> • One door • Butt doors available on 42 x 42 cabinet • Two hinges per door • Soft close hinge upgrade available, see page 5 • No drawer • Premium all wood package upgrade available 		<table border="1" style="width: 100%; border-collapse: collapse;"> <tr> <th>MODEL NUMBER</th> <th>ITEM NUMBER</th> </tr> <tr> <td>DSBC36X36</td> <td>BDC363634</td> </tr> <tr> <td>DSBC42X42</td> <td>BDC424234</td> </tr> <tr> <td>DSB36X36</td> <td>BDI363634</td> </tr> <tr> <td>DSB42X42</td> <td>BDI424234</td> </tr> </table>	MODEL NUMBER	ITEM NUMBER	DSBC36X36	BDC363634	DSBC42X42	BDC424234	DSB36X36	BDI363634	DSB42X42	BDI424234
MODEL NUMBER	ITEM NUMBER												
DSBC36X36	BDC363634												
DSBC42X42	BDC424234												
DSB36X36	BDI363634												
DSB42X42	BDI424234												

Base Angle Cabinets

<p>Height: 34½" Short Side: 12" Long Side: 24" Back: 12" Front Face: 17½" Left angle shown</p>  <p>Cabinet Angle Degree: 135°</p>	<ul style="list-style-type: none"> • One door • Two hinges per door • Soft close hinge upgrade available, see page 5 • BAR - Right angle cabinet • BAL - Left angle cabinet • Premium all wood package upgrade available 		<table border="1" style="width: 100%; border-collapse: collapse;"> <tr> <th>MODEL NUMBER</th> <th>ITEM NUMBER</th> </tr> <tr> <td>BAC12L</td> <td>BAL122434</td> </tr> <tr> <td>BAC12R</td> <td>BAR122434</td> </tr> </table>	MODEL NUMBER	ITEM NUMBER	BAC12L	BAL122434	BAC12R	BAR122434
MODEL NUMBER	ITEM NUMBER								
BAC12L	BAL122434								
BAC12R	BAR122434								

All shelves and bottoms are rated to withstand 15 lbs. per square foot.

For additional cabinet options, please see page 5.

Base Cabinets

Base Corner Cabinets 33" x 33" and 36" x 36"

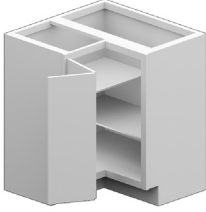
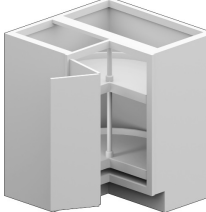
BER - Easy Reach Ends: 18" 		BLZ - Lazy Susan w/ 165 Degree Hinge Ends: 18" 	
<ul style="list-style-type: none"> • Easy Reach door • Two hinges per door • Two shelves • Premium all wood package upgrade available 		<ul style="list-style-type: none"> • Easy Reach door • Two hinges per door • Two trays • Tray weight capacity: 75 lbs 	
<ul style="list-style-type: none"> • Tray dimensions: 33 x 33: 24" diameter; 36 x 36: 28" diameter • Heavy duty lazy susan wooden tray upgrade available • Premium all wood package upgrade available 			
MODEL NUMBER CBER3333 CBER3636	ITEM NUMBER BER333334 BER363634	MODEL NUMBER BLS3333 BLS3636	ITEM NUMBER BLZ333334 BLZ363634

Base Corner Cabinets 36" x 36"

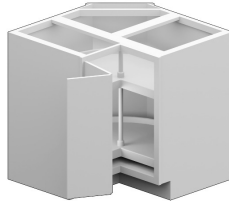
BZR - Revolving Door Lazy Susan 		BDL - Super Susan Ends: 23 1/4" 	
<ul style="list-style-type: none"> • Revolving Lazy Susan door • Two trays • Tray weight capacity: 75 lbs • Tray dimensions: 24" diameter • Premium all wood package upgrade available 		<ul style="list-style-type: none"> • Easy Reach door • Two hinges per door • Two trays • Tray weight capacity: 75 lbs • Tray dimensions: 32" diameter 	
<ul style="list-style-type: none"> • Heavy duty lazy susan wooden tray upgrade available • Premium all wood package upgrade available 			
MODEL NUMBER BZR3636	ITEM NUMBER BZR363634	MODEL NUMBER SS36	ITEM NUMBER BDL363634

Wastebasket Cabinets 15" Wide

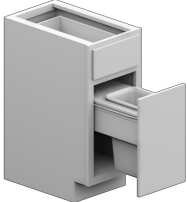
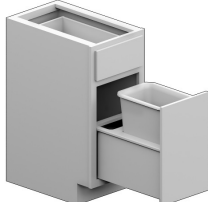
15 W 34 1/2 H 24 D 	<ul style="list-style-type: none"> • One drawer • One container • Heavy duty full extension, soft close upgrade available (See image on right) • Premium all wood package upgrade available • Maximum load capacity: 75 lbs 		
	MODEL NUMBER BWB15	ITEM NUMBER BWB152434	

Wastebasket Cabinets 18" Wide

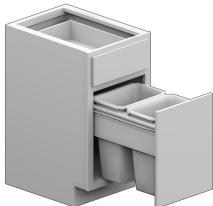
18 W 34 1/2 H 24 D 	<ul style="list-style-type: none"> • One drawer • Two containers • Heavy duty full extension, soft close upgrade available • Premium all wood package upgrade available • Maximum load capacity: 75 lbs 	
	MODEL NUMBER BWB18	ITEM NUMBER BWB182434

NOTE: Full Ht Doors are not available on Wastebasket Cabinets

All shelves and bottoms are rated to withstand 15 lbs. per square foot.

For additional cabinet options, please see page 5.

Base Cabinets

Tray Cabinets

9 W
34½ H
24 D



- One door and two hinges per door
- Soft close hinge upgrade available, see page 5
- No drawer
- No shelves
- Premium all wood package upgrade available
- Pull out spice rack upgrade available; specify BPO instead of BTR

MODEL NUMBER
BT9
BP09

ITEM NUMBER
BTR092434
BP092434

Blind Base Cabinets

36 - 48 W
34½ H
24 D

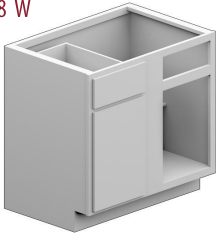

Blind Corner Base Cabinets

- One door and two hinges per door
- Soft close hinge upgrade available, see page 5
- One fixed shelf
- Specify Left or Right blind
- Premium all wood package upgrade available
- Please reference drawings below for (A), (B), (C), (D) cabinet measurements

Door Hardware Clearance F/O Door Hardware Clearance S/O

MODEL NUMBER	ITEM NUMBER	CAB. WIDTH (A)	MIN. S/O (B)	MAX. (C)	MIN. F/O (D)	Door Hardware Clearance F/O		Door Hardware Clearance S/O	
						Min. Pull	Max. Pull	Min. Pull	Max. Pull
BCC36-39	BCC362434	27	37	39	38				
BCC39-42	BCC392434	30	39	42	40				
BCC42-45	BCC422434	36	42	45	43	1 1/16	2 1/16	1 3/16	2 13/16
BCC45-48	BCC452434	42	45	48	46				
BCC48-51	BCC482434	48	48	51	49				

Illustration - Base Cabinets

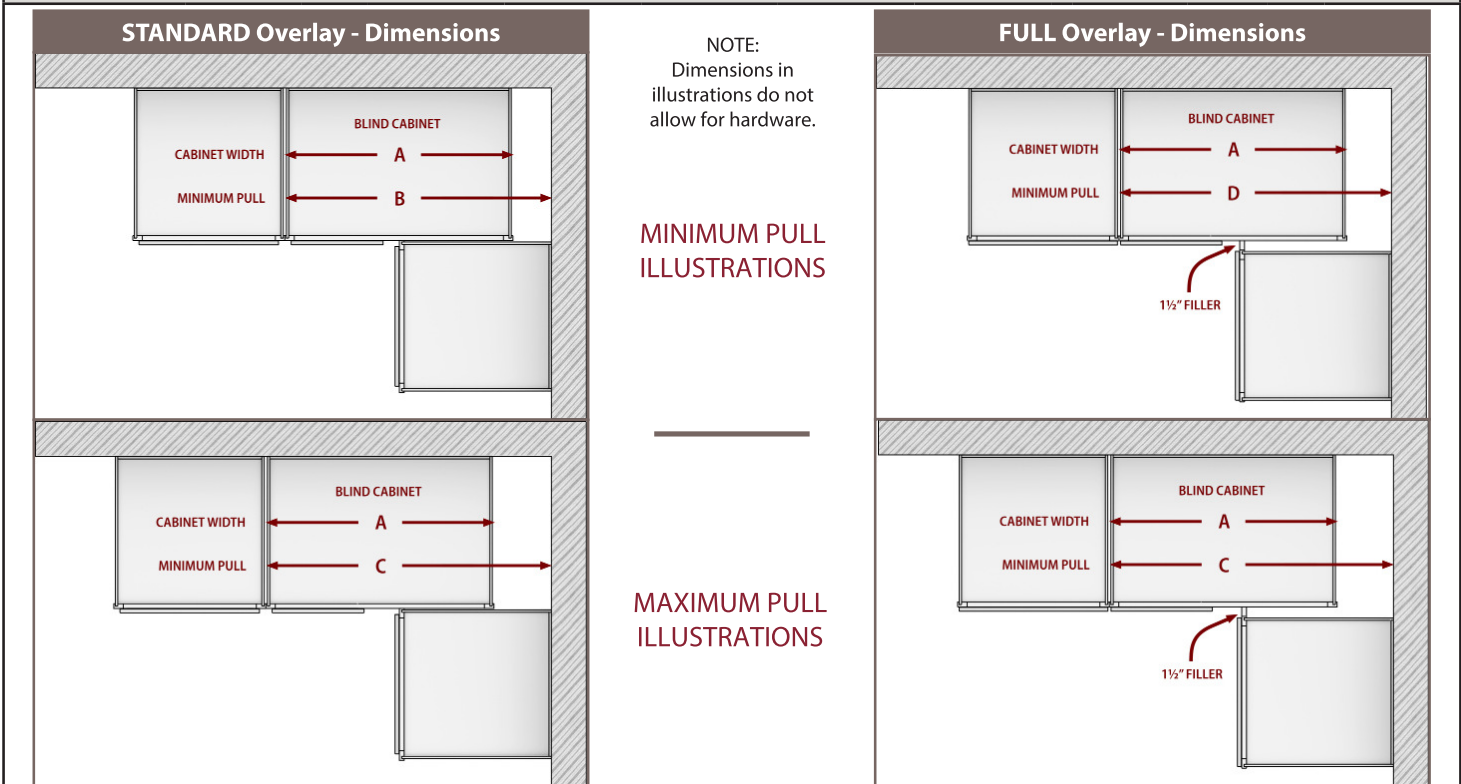

All shelves and bottoms are rated to withstand 15 lbs. per square foot.

For additional cabinet options, please see page 5.

Microwave/Oven Cabinets

Base Microwave Cabinets

30 W
34½ H
24 D



Microwave Opening:
24 W x 17¼ H
(Trimmable)

- One drawer
- Drawer weight capacity: 75 lbs
- Soft close hinge upgrade available, see page 5
- Premium all wood package upgrade available

MODEL NUMBER
BMC3024

ITEM NUMBER
BMC302434

Oven Cabinets

27, 30, 33 W
84, 90, 96 H
24 D



Oven Opening:
Height = 24½"
Width = 6" Less than
Cabinet Width
(Trimmable)

- Butt doors
- Two hinges per door
- Soft close hinge and drawer upgrade available, see page 5
- Three drawers; removable for double oven cabinet
- Drawer weight capacity: 75 lbs
- Premium all wood package upgrade available

MODEL NUMBER
OC272484
OC272490
OC272496
OC302484
OC302490
OC302496
OC332484
OC332490
OC332496

ITEM NUMBER
OVS272484
OVS272490
OVS272496
OVS302484
OVS302490
OVS302496
OVS332484
OVS332490
OVS332496

Oven with Microwave Cabinets

27, 30, 33 W
84, 90, 96 H
24 D



Oven Opening:
Height = 25½"
Width = 6" Less than
Cabinet Width
(Trimmable)

Microwave Opening:
Height = 16½" H
Width = 3" Less than
Cabinet Width

- Butt doors
- Two hinges per door
- Soft close hinge upgrade available, see page 5
- One drawer
- Drawer weight capacity: 75 lbs
- Premium all wood package upgrade available

MODEL NUMBER	ITEM NUMBER
OM2784	OMS272484
OM2790	OMS272490
OM2796	OMS272496
OM3084	OMS302484
OM3090	OMS302490
OM3096	OMS302496
OM3384	OMS332484
OM3390	OMS332490
OM3396	OMS332496

Double Oven Cabinets

27, 30, 33 W
84, 90, 96 H
24 D



Oven Opening:
Height = 47¼"
Width = 6" Less than
Cabinet Width
(Trimmable)

MODEL NUMBER	ITEM NUMBER
D0272484	OVD272484
D0272490	OVD272490
D0272496	OVD272496
D0302484	OVD302484
D0302490	OVD302490
D0302496	OVD302496
D0332484	OVD332484
D0332490	OVD332490
D0332496	OVD332496

All shelves and bottoms are rated to withstand 15 lbs. per square foot.

For additional cabinet options, please see page 5.

Utility Cabinets

Utility Cabinets 84" - 96" Tall

12 - 24 W
84 - 96 H
12 - 24 D



24, 30, 36 W
84 - 96 H
15 - 24 D



- Two doors standard on cabinets 12-24" W
- Butt doors available on cabinet 24" W
- Butt doors standard on cabinet 30" and 36" W
- Two hinges on top door, three hinges on bottom door
- Drilled for shelving, shelf kits sold separately
- Please reference shelf kits (page 31) for shelving options and sizes.
- Premium all wood package upgrade available
- Glass and mullion available in top doors only
- Soft close hinge upgrade available, see page 5

84" Tall

90" Tall

96" Tall

84" Tall		90" Tall		96" Tall	
MODEL NUMBER	ITEM NUMBER	MODEL NUMBER	ITEM NUMBER	MODEL NUMBER	ITEM NUMBER
UC122484	UCB122484	UC122490	UCB122490	UC122496	UCB122496
UC151284	UCB151284	UC151290	UCB151290	UC151296	UCB151296
UC151884	UCB151884	UC151890	UCB151890	UC151896	UCB151896
UC152184	UCB152184	UC152190	UCB152190	UC152196	UCB152196
UC152484	UCB152484	UC152490	UCB152490	UC152496	UCB152496
UC181284	UCB181284	UC181290	UCB181290	UC181296	UCB181296
UC181884	UCB181884	UC181890	UCB181890	UC181896	UCB181896
UC182184	UCB182184	UC182190	UCB182190	UC182196	UCB182196
UC182484	UCB182484	UC182490	UCB182490	UC182496	UCB182496
UC211284	UCB211284	UC211290	UCB211290	UC211296	UCB211296
UC211884	UCB211884	UC211890	UCB211890	UC211896	UCB211896
UC212184	UCB212184	UC212190	UCB212190	UC212196	UCB212196
UC212484	UCB212484	UC212490	UCB212490	UC212496	UCB212496
UC241284	UCB241284	UC241290	UCB241290	UC241296	UCB241296
UC241884	UCB241884	UC241890	UCB241890	UC241896	UCB241896
UC242184	UCB242184	UC242190	UCB242190	UC242196	UCB242196
UC242484	UCB242484	UC242490	UCB242490	UC242496	UCB242496
UC302184	UCB302184	UC302190	UCB302190	UC302196	UCB302196
UC302484	UCB302484	UC302490	UCB302490	UC302496	UCB302496
UC362184	UCB362184	UC362190	UCB362190	UC362196	UCB362196
UC362484	UCB362484	UC362490	UCB362490	UC362496	UCB362496

All shelves and bottoms are rated to withstand 15 lbs. per square foot.

For additional cabinet options, please see page 5.

Shelf Kits

Premium Plywood



Standard Elegant or White



MDF



MDF

<ul style="list-style-type: none"> Available in two shelf or four shelf kits ½" (A4) or ¾" (A6) thickness Elegant color standard: white available to match cabinet interior Shelves are rated to withstand 15 lbs per square foot 	MODEL NUMBER	ITEM NUMBER	MODEL NUMBER	ITEM NUMBER	MODEL NUMBER	ITEM NUMBER	
	2SK2724	2SK2724A4X	4SK1224	4SK1224A4X	4SK1818	4SK1818A4X	
	2SK3024	2SK3024A4X	4SK1512	4SK1512A4X	4SK1821	4SK1821A4X	
	2SK3324	2SK3324A4X	4SK1518	4SK1518A4X	4SK1824	4SK1824A4X	
	2SK2724.75	2SK2724A6X	4SK1521	4SK1521A4X	4SK2112	4SK2112A4X	
	2SK3024.75	2SK3024A6X	4SK1524	4SK1524A4X	4SK2118	4SK2118A4X	
	2SK3324.75	2SK3324A6X	4SK1812	4SK1812A4X	4SK2121	4SK2121A4X	
MODEL NUMBER	ITEM NUMBER	MODEL NUMBER	ITEM NUMBER	MODEL NUMBER	ITEM NUMBER	MODEL NUMBER	ITEM NUMBER
4SK2124	4SK2124A4X	4SK1224.75	4SK1224A6X	4SK1818.75	4SK1818A6X	4SK2124.75	4SK2124A6X
4SK2412	4SK2412A4X	4SK1512.75	4SK1512A6X	4SK1821.75	4SK1821A6X	4SK2412.75	4SK2412A6X
4SK2418	4SK2418A4X	4SK1518.75	4SK1518A6X	4SK1824.75	4SK1824A6X	4SK2418.75	4SK2418A6X
4SK2421	4SK2421A4X	4SK1521.75	4SK1521A6X	4SK2112.75	4SK2112A6X	4SK2421.75	4SK2421A6X
4SK2424	4SK2424A4X	4SK1521.75	4SK1524A6X	4SK2118.75	4SK2118A6X	4SK2424.75	4SK2424A6X
4SK3024	4SK3024A4X	4SK1812.75	4SK1812A6X	4SK2121.75	4SK2121A6X	4SK3024.75	4SK3024A6X
4SK3624	4SK3624A4X					4SK3624.75	4SK3624A6X

Premium

<ul style="list-style-type: none"> Available in two shelf or four shelf kits ½" (A4-D) or ¾" (A6-D) thickness Elegant color standard: white available to match cabinet interior Shelves are rated to withstand 15 lbs per square foot 	MODEL NUMBER	ITEM NUMBER	MODEL NUMBER	ITEM NUMBER	MODEL NUMBER	ITEM NUMBER	
	2SK2724.5D	2SK2724A4D	4SK1224.5D	4SK1224A4D	4SK1818.5D	4SK1818A4D	
	2SK3024.5D	2SK3024A4D	4SK1512.5D	4SK1512A4D	4SK1821.5D	4SK1821A4D	
	2SK3324.5D	2SK3324A4D	4SK1518.5D	4SK1518A4D	4SK1824.5D	4SK1824A4D	
	2SK2724.75D	2SK2724A6D	4SK1521.5D	4SK1521A4D	4SK2112.5D	4SK2112A4D	
	2SK3024.75D	2SK3024A6D	4SK1524.5D	4SK1524A4D	4SK2118.5D	4SK2118A4D	
	2SK3324.75D	2SK3324A6D	4SK1812.5D	4SK1812A4D	4SK2121.5D	4SK2121A4D	
MODEL NUMBER	ITEM NUMBER	MODEL NUMBER	ITEM NUMBER	MODEL NUMBER	ITEM NUMBER	MODEL NUMBER	ITEM NUMBER
4SK2124.5D	4SK2124A4D	4SK1224.75D	4SK1224A6D	4SK1818.75D	4SK1818A6D	4SK2124.75D	4SK2124A6D
4SK2412.5D	4SK2412A4D	4SK1512.75D	4SK1512A6D	4SK1821.75D	4SK1821A6D	4SK2412.75D	4SK2412A6D
4SK2418.5D	4SK2418A4D	4SK1518.75D	4SK1518A6D	4SK1824.75D	4SK1824A6D	4SK2418.75D	4SK2418A6D
4SK2421.5D	4SK2421A4D	4SK1521.75D	4SK1521A6D	4SK2112.75D	4SK2112A6D	4SK2421.75D	4SK2421A6D
4SK2424.5D	4SK2424A4D	4SK1524.75D	4SK1524A6D	4SK2118.75D	4SK2118A6D	4SK2424.75D	4SK2424A6D
4SK3024.5D	4SK3024A4D	4SK1812.75D	4SK1812A6D	4SK2121.75D	4SK2121A6D	4SK3024.75D	4SK3024A6D
4SK3624.5D	4SK3624A4D					4SK3624.75D	4SK3624A6D

White 2 and 4-Shelf Kits

Add "WHX" to the end of the Item Number.

For Model Number, use "2SKW" / "4SKW" respectively at the beginning.

Touch-Up Kit

- Contains: top coat, scotch bright pad, fill stick, and felt/stain marker



Office Cabinets

Book Cases 24", 30", 36"

24, 30, 36 W
60 H
12 or 15 D



- Four ¾" adjustable shelves
- Matching interior included

MODEL NUMBER
BC2460
BC3060
BC3660
BC246015
BC306015
BC366015

ITEM NUMBER
ZBC246012
ZBC306012
ZBC366012
ZBC246015
ZBC306015
ZBC366015

File Cabinet 18"

18 W
28 H
24 D



- Three drawers; one file drawer option available
- Two file drawer option available
- Drawer weight capacity: 75 lbs
- Available in full overlay only



MODEL NUMBER
N/A

ITEM NUMBER
K1F182428

MODEL NUMBER
N/A

ITEM NUMBER
K2F182428

File Cabinet 30"

30 W
28 H
24 D



- Two lateral file drawers
- Drawer weight capacity: 75 lbs
- Available in full overlay only

MODEL NUMBER
N/A

ITEM NUMBER
KLF302428

File Cabinet Notes

Cabinet Box Construction

- Vinyl covered ¾" plywood. (Premium all wood)

Drawers

- ½" finished solid wood
- Dovetail construction
- Drawers glide smoothly on full extension heavy duty guides

Options

- Finished Veneer Sides (see page 5)
- 5-Piece Drawer Front (see pages 8-14)

All shelves and bottoms are rated to withstand 15 lbs. per square foot.

For additional cabinet options, please see page 5.

Vanity Cabinets

Vanity Sink Bases 18" - 24" Wide

18 - 24 W
31½ H or 34½ H
16, 18 or 21 D



- One door
- Butt door option available on 24" W
- Two hinges per door
- One false drawer front
- Soft close hinge upgrade available, see page 5

MODEL NUMBER	ITEM NUMBER
VSB1816	VSB181631
VSB1818	VSB181831
VSB18	VSB182131
VSB21	VSB212131
VSB2418	VSB241831
VSB24	VSB242131
VSB181634	VSB181634
VSB182134	VSB182134
VSB212134	VSB212134
VSB241834	VSB241834
VSB242134	VSB242134

Vanity Sink Bases 27" - 36" Wide

27 - 36 W
31½ H or 34½ H
18 or 21 D

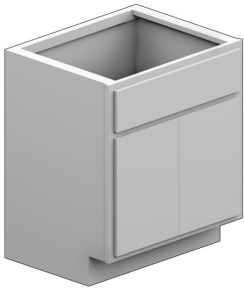

- Butt doors standard on cabinets 27"-36" W
- Two hinges per door
- One false drawer front
- Soft close hinge upgrade available, see page 5

MODEL NUMBER	ITEM NUMBER
VSB2718	VSB271831
VSB27	VSB272131
VSB3018	VSB301831
VSB30	VSB302131
VSB3318	VSB331831
VSB33	VSB332131

MODEL NUMBER	ITEM NUMBER
VSB3618	VSB361831
VSB36	VSB362131
VSB271834	VSB271834
VSB272134	VSB272134
VSB302134	VSB302134
VSB331834	VSB331834
VSB332134	VSB332134
VSB361834	VSB361834
VSB362134	VSB362134

Vanity Sink Bases 39" - 48" Wide

39 - 48 W
31½ H or 34½ H
18 or 21 D

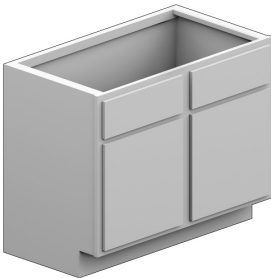

- Two doors
- Two hinges per door
- Two false drawer fronts
- Soft close hinge available, see page 5

MODEL NUMBER	ITEM NUMBER
VSB3918	VSB391831
VSB39	VSB392131
VSB4218	VSB421831
VSB42	VSB422131
VSB45	VSB452131

MODEL NUMBER	ITEM NUMBER
VSB4818	VSB481831
VSB48	VSB482131
VSB391834	VSB391834
VSB392134	VSB392134
VSB421834	VSB421834
VSB422134	VSB422134
VSB452134	VSB452134
VSB482134	VSB482134

Vanity Sink Bases - Top Drawer 36" Wide

36 W
31½ H or 34½ H
18 or 21 D

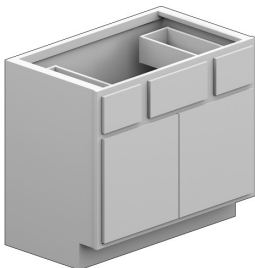

- Butt doors
- Two hinges per door
- Two drawers; one at each end
- Drawer weight capacity: 75 lbs
- Dovetail drawers standard
- Soft close hinge and drawer upgrade available, see page 5
- One false drawer front in the middle

MODEL NUMBER	ITEM NUMBER
VBTD3618	VBT361831
VBTD36	VBT362131
VBTD361834	VBT361834
VBTD362134	VBT362134

All vanities include a finished toe kick. All shelves and bottoms are rated to withstand 15 lbs. per square foot.

For additional cabinet options, please see page 5.

Vanity Cabinets

Vanity Sink Bases - Top Drawer 39" - 48" Wide

39 - 48 W
31½ H or 34½ H
21 D

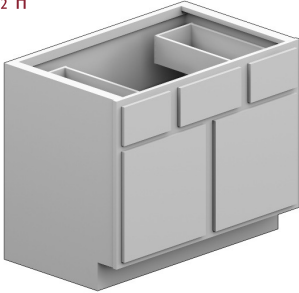

- Two doors
- Two hinges per door
- Two drawers; one at each end
- Not available in full height door
- Drawer weight capacity: 75 lbs
- Dovetail drawers standard
- Soft close hinge/drawer upgrade available, see pg. 5
- One false drawer front in the middle

MODEL NUMBER

VBTD3918
VBTD39
VBTD4218

ITEM NUMBER

VBT391831
VBT392131
VBT421831

MODEL NUMBER

VBTD42
VBTD45
VBTD4818
VBTD48
VBTD391834
VBTD392134
VBTD421834
VBTD422134
VBTD452134
VBTD481834
VBTD482134

ITEM NUMBER

VBT422131
VBT452131
VBT481831
VBT482131
VBT391834
VBT392134
VBT421834
VBT422134
VBT452134
VBT481834
VBT482134

Vanity Base Cabinets 12" - 24" Wide

12 - 24 W
31½ H or 34½ H
21 D

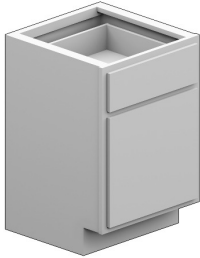

- One door 12 - 24 W
- Butt door option available on cabinet 24 W
- Two hinges per door
- One fixed shelf and one drawer
- Drawer weight capacity: 75 lbs
- Dovetail drawer standard
- Soft close hinge/drawer upgrade available, see pg. 5

MODEL NUMBER

VB12
VB15
VB18
VB21
VB24
VB122134
VB152134
VB182134
VB212134
VB242134

ITEM NUMBER

VAB122131
VAB152131
VAB182131
VAB212131
VAB242131
VAB122134
VAB152134
VAB182134
VAB212134
VAB242134

Vanity Base Cabinets 27" - 36" Wide

27 - 36 W
31½ H or 34½ H
21 D

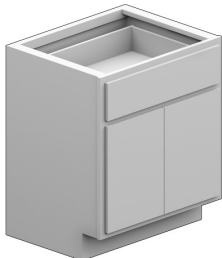

- Butt doors standard
- Two hinges per door
- One fixed shelf and one drawer
- Drawer weight capacity: 75 lbs
- Dovetail drawer standard
- Soft close hinge/drawer upgrade available, see pg. 5

MODEL NUMBER

VB27
VB30
VB33
VB36
VB272134
VB302134
VB332134
VB362134

ITEM NUMBER

VAB272131
VAB302131
VAB332131
VAB362131
VAB272134
VAB302134
VAB332134
VAB362134

Vanity Base Cabinets 39" - 48" Wide

39 - 48 W
31½ H or 34½ H
21 D

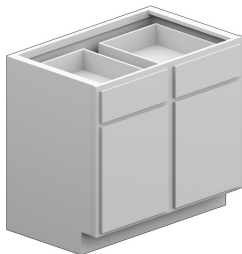

- Two doors
- Two hinges per door
- One fixed shelf and two drawers
- Drawer weight capacity: 75 lbs
- Dovetail drawer standard
- Soft close hinge/drawer upgrade available, see pg. 5

MODEL NUMBER

VB39
VB42
VB45
VB48
VB392134
VB422134
VB452134
VB482134

ITEM NUMBER

VAB392131
VAB422131
VAB452131
VAB482131
VAB392134
VAB422134
VAB452134
VAB482134

All vanities include a finished toe kick. All shelves and bottoms are rated to withstand 15 lbs. per square foot.

For additional cabinet options, please see page 5.

Vanity Cabinets

Vanity Drawers 12-24" Wide

12, 15,
18 or 24 W
31½ H
21 D



12, 15,
18, or 24 W
34½ H
21 D



12, 15,
18, or 24 W
34½ H
18 or 21 D



- Available in 31½ or 34½ height
- 31½ H cabinet: three drawers
- 34½ H cabinet: three or four drawers, 18 or 21 deep
- Drawer weight capacity: 75 lbs
- Dovetail drawers standard
- Soft close, full extension upgrade available, see page 5
- Premium all wood package upgrade available

MODEL NUMBER	ITEM NUMBER	MODEL NUMBER	ITEM NUMBER	MODEL NUMBER	ITEM NUMBER	MODEL NUMBER	ITEM NUMBER
VDB12	VDB122131	VDB182134	VDB182134	V3D181834	V3D181834	V3D301834	V3D301834
VDB15	VDB152131	VDB242134	VDB242134	V3D1834	V3D182134	V3D3034	V3D302134
VDB18	VDB182131	V3D121834	V3D121834	V3D211834	V3D211834	V3D331834	V3D331834
VDB24	VDB242131	V3D1234	V3D122134	V3D2134	V3D212134	V3D3334	V3D332134
VDB122134	VDB122134	V3D151834	V3D151834	V3D241834	V3D241834	V3D361834	V3D361834
VDB152134	VDB152134	V3D1534	V3D152134	V3D2434	V3D242134	V3D3634	V3D362134

Vanity Sink Bases - Drawer Bank 24"-33" Wide

24 or 30 W
31½ or 34½ H
18 or 21 D

31½ H VRD
shown

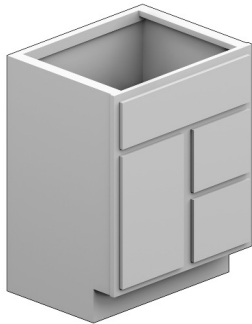

- One door; no hinges per door
- One false drawer front
- Not available in full height door
- Available in 31½ or 34½ height
- 31½ H cabinet; two drawers
- 34½ H cabinet; three drawers
- Drawer weight capacity: 75 lbs
- Dovetail drawers standard
- Soft close hinge and drawer upgrade available, see page 5
- Premium all wood package upgrade available
- Left drawer bank available; specify VLD instead of VRD

MODEL NUMBER	ITEM NUMBER	MODEL NUMBER	ITEM NUMBER
VRDD2418	VRD241831	VRDD241834	VRD241834
VRDD2718	VRD271831	VRDD271834	VRD271834
VRDD3018	VRD301831	VRDD301834	VRD301834
VRDD3318	VRD331831	VRDD331834	VRD331834
VRDD24	VRD242131	VRDD242134	VRD242134
VRDD27	VRD272131	VRDD272134	VRD272134
VRDD30	VRD302131	VRDD302134	VRD302134
VRDD33	VRD332131	VRDD332134	VRD332134

Vanity Sink Bases - Drawer Bank 36"-48" Wide

36 W
31½ or 34½ H
18 or 21 D

31½ H VRD
shown

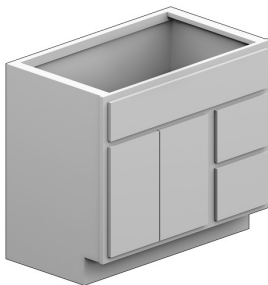

- Butt doors
- Two hinges per door
- One false drawer front
- Not available in full height door
- 36 W & 31½ H; two drawers
- 39 - 48 W & 31½ H; three drawers
- 36 W & 34½ H; three drawers
- 39 - 48 W & 34½ H; three drawers
- Drawer weight capacity: 75 lbs
- Dovetail drawers standard
- Soft close hinge and drawer upgrade available, see page 5
- Premium all wood package upgrade available
- Left drawer bank available; specify VLD instead of VRD

39 - 48 W
31½ or 34½ H
18 or 21 D

Drawer bank
equivalent to
12" base

34½ H VRD
shown

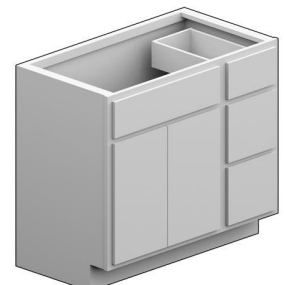

MODEL NUMBER	ITEM NUMBER	MODEL NUMBER	ITEM NUMBER	MODEL NUMBER	ITEM NUMBER	MODEL NUMBER	ITEM NUMBER
VRDD3618	VRD361831	VRDD36	VRD362131	VRDD361834	VRD361834	VRDD362134	VRD362134
VRDD3918	VRD391831	VRDD39	VRD392131	VRDD391834	VRD391834	VRDD392134	VRD392134
VRDD4218	VRD421831	VRDD42	VRD422131	VRDD421834	VRD421834	VRDD422134	VRD422134
VRDD4518	VRD451831	VRDD45	VRD452131	VRDD451834	VRD451834	VRDD452134	VRD452134
VRDD4818	VRD481831	VRDD48	VRD482131	VRDD481834	VRD481834	VRDD482134	VRD482134

All vanities include a finished toe kick. All shelves and bottoms are rated to withstand 15 lbs. per square foot.

For additional cabinet options, please see page 5.

Vanity Cabinets

Vanity Sink Bases - Center Drawer Bank

60 W
31½ or 34½ H
18 or 21 D

31½ H VCD
shown

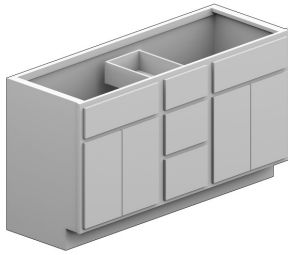

- Butt doors on each end
- Two hinges per door
- Two false drawer fronts; one at each end
- Not available in full height door
- 31½ H cabinet; three drawers
- 34½ H cabinet; three drawers
- Drawer weight capacity: 75 lbs
- Dovetail drawers standard
- Soft close hinge and drawer upgrade available, see page 5
- Premium all wood package upgrade available

MODEL NUMBER
VCDD6018
VCCD60
VCDD601834
VCDD602134

ITEM NUMBER
VCD601831
VCD602131
VCD601834
VCD602134

Vanity Sink Bases - Drawer Bank Each End

48 or 60 W
31½ or 34½ H
18 or 21 D

31½ H VED
shown

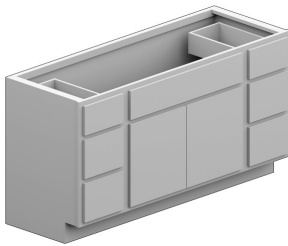

- Butt doors
- Two hinges per door
- One false drawer front
- Not available in full height door
- 31½ H cabinet; three drawers at each end, six total
- 34½ H cabinet; three drawers at each end, eight total
- Drawer weight capacity: 75 lbs
- Dovetail drawers standard
- Soft close hinge and drawer upgrade available, see page 5
- Premium all wood package upgrade available

MODEL NUMBER
VEDD4818
VEDD48
VEDD6018
VEDD60
VEDD481834
VEDD482134
VEDD601834
VEDD602134

ITEM NUMBER
VED481831
VED482131
VED601831
VED602131
VED481834
VED482134
VED601834
VED602134

Vanity Starter Cabinets

54, 60, 72 W
31½ or 34½ H
18 or 21 D

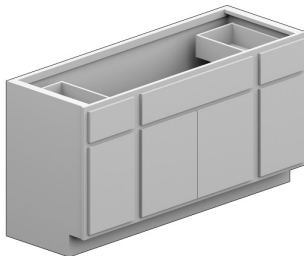

- Center butt doors
- One door at each end
- Two hinges per door
- Two drawers, one at each end
- Drawer weight capacity: 75 lbs
- One false drawer front
- Dovetail drawers standard
- Soft close hinge and drawer upgrade available, see page 5
- Premium all wood package upgrade available

MODEL NUMBER
VSTB5418
VSTB54
VSTB6018
VSTB60
VSTB72
VSTB541834
VSTB542134
VSTB601834
VSTB602134
VSTB721834
VSTB722134

ITEM NUMBER
VST541831
VST542131
VST601831
VST602131
VST722131
VST541834
VST542134
VST601834
VST602134
VST721834
VST722134

Utility Cabinet with Drawers

18 W
80 H
21 D



- One door
- Three hinges per door
- Three drawers
- Dovetail drawers standard
- Soft close hinge and drawer upgrade available, see page 5
- Three adjustable shelves
- Premium all wood package upgrade available

MODEL NUMBER
UT182180

ITEM NUMBER
U3D182180

All vanities include a finished toe kick. All shelves and bottoms are rated to withstand 15 lbs. per square foot.

For additional cabinet options, please see page 5.

Furniture Vanity Cabinets

Furniture Vanity Sink Bases 24" Wide													
<p>24 W 34½ H 18 or 21 D</p>		<ul style="list-style-type: none"> • One door • Butt door option available • Two hinges per door • Soft close hinge upgrade available, see page 5 • One false drawer front • Premium all wood package upgrade available 	<table border="1"> <tr> <th>MODEL NUMBER</th> <th>ITEM NUMBER</th> </tr> <tr> <td>FVSB241834</td> <td>VSB2418F4</td> </tr> <tr> <td>FVSB2434</td> <td>VSB2421F4</td> </tr> </table>	MODEL NUMBER	ITEM NUMBER	FVSB241834	VSB2418F4	FVSB2434	VSB2421F4				
MODEL NUMBER	ITEM NUMBER												
FVSB241834	VSB2418F4												
FVSB2434	VSB2421F4												
Furniture Vanity Sink Bases 27" - 36" Wide													
<p>27 - 36 W 34½ H 21 D</p>		<ul style="list-style-type: none"> • Butt doors • Two hinges per door • Soft close hinge upgrade available, see page 5 • One false drawer front • Premium all wood package upgrade available 	<table border="1"> <tr> <th>MODEL NUMBER</th> <th>ITEM NUMBER</th> </tr> <tr> <td>FVSB2734</td> <td>VSB2721F4</td> </tr> <tr> <td>FVSB3034</td> <td>VSB3021F4</td> </tr> <tr> <td>FVSB3634</td> <td>VSB3621F4</td> </tr> </table>	MODEL NUMBER	ITEM NUMBER	FVSB2734	VSB2721F4	FVSB3034	VSB3021F4	FVSB3634	VSB3621F4		
MODEL NUMBER	ITEM NUMBER												
FVSB2734	VSB2721F4												
FVSB3034	VSB3021F4												
FVSB3634	VSB3621F4												
Furniture Vanity Sink Bases 42" and 48" Wide													
<p>42 or 48 W 34½ H 21 D</p>		<ul style="list-style-type: none"> • Two doors • Two hinges per door • Soft close hinge upgrade available, see page 5 • Two false drawer fronts • Premium all wood package upgrade available 	<table border="1"> <tr> <th>MODEL NUMBER</th> <th>ITEM NUMBER</th> </tr> <tr> <td>FVSB4234</td> <td>VSB4221F4</td> </tr> <tr> <td>FVSB4834</td> <td>VSB4821F4</td> </tr> </table>	MODEL NUMBER	ITEM NUMBER	FVSB4234	VSB4221F4	FVSB4834	VSB4821F4				
MODEL NUMBER	ITEM NUMBER												
FVSB4234	VSB4221F4												
FVSB4834	VSB4821F4												
Furniture Vanity Sink Bases - Drawer Bank 24" - 30" Wide													
<p>24 or 30 W 34½ H 18 or 21 D</p> <p>Drawer bank equivalent to 12" base</p>	<p>VRD Shown</p>	<ul style="list-style-type: none"> • One door • Two hinges per door • Not available in full height door • One false drawer front • Two drawers • Drawer weight capacity: 75 lbs • Dovetail drawers standard • Soft close hinge and drawer upgrade available, see page 5 • Premium all wood package upgrade available • Left drawer bank available; specify VLD instead of VRD 	<table border="1"> <tr> <th>MODEL NUMBER</th> <th>ITEM NUMBER</th> </tr> <tr> <td>FVRDD241834</td> <td>VRD2418F4</td> </tr> <tr> <td>FVRDD2434</td> <td>VRD2421F4</td> </tr> <tr> <td>FVRDD301834</td> <td>VRD3018F4</td> </tr> <tr> <td>FVRDD3034</td> <td>VRD3021F4</td> </tr> </table>	MODEL NUMBER	ITEM NUMBER	FVRDD241834	VRD2418F4	FVRDD2434	VRD2421F4	FVRDD301834	VRD3018F4	FVRDD3034	VRD3021F4
MODEL NUMBER	ITEM NUMBER												
FVRDD241834	VRD2418F4												
FVRDD2434	VRD2421F4												
FVRDD301834	VRD3018F4												
FVRDD3034	VRD3021F4												
<ul style="list-style-type: none"> - Cabinet box is 27 H - Tapered feet are tapered two sides - Tapered and bun feet are 6¾ H - Legs are mounted on a ¾ thick platform 	<p>Furniture Vanity Height Codes</p> <p>F4 = 34½" Tall F5 = 80" Tall</p>	<p>Furniture Vanities feature 4 Bunn feet or 4 Tapered feet that are installed during the production process.</p>											
	<p>Classic Harmony Vanderburgh Williamsburg</p>			<p>Durham Georgetown Jamestown Kingston Mission Rentown Urbana Youngstown</p>									

All shelves and bottoms are rated to withstand 15 lbs. per square foot.

For additional cabinet options, please see page 5.

Furniture Vanity Cabinets



Furniture Vanity Sink Bases - Drawer Bank 36" - 48" Wide

<p>36 - 48 W 34½ H 18 or 21 D</p> <p>Drawer bank equivalent to 12" base</p> <p>VRD Shown</p>		<ul style="list-style-type: none"> Butt doors Two hinges per door Not available in full height door One false drawer front 36 W two drawers 42 or 48 W three drawers Drawer weight capacity: 75 lbs Dovetail drawers standard Soft close hinge and drawer upgrade available, see page 5 Premium all wood package upgrade available Left drawer bank available; specify VLD instead of VRD 	<p>MODEL NUMBER</p> <p>FVRDD361834 FVRDD3634 FVRDD421834 FVRDD4234 FVRDD4834</p>	<p>ITEM NUMBER</p> <p>VRD3618F4 VRD3621F4 VRD4218F4 VRD4221F4 VRD4821F4</p>
--	---	--	---	--

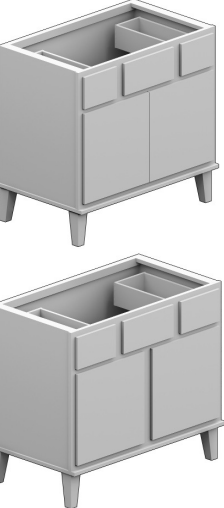
Furniture Vanity Sink Bases - Top Drawer 36-48" Wide

<p>36-48 W 34½ H 21 D</p>		<ul style="list-style-type: none"> Two Doors: 36 W butt doors; 39 - 48 W center stile Two hinges per door Not available in full height door One false drawer front Two drawers, one at each end Drawer weight capacity: 75 lbs Dovetail drawers standard Soft close hinge and drawer upgrade available, see page 5 Premium all wood package upgrade available. 	<p>MODEL NUMBER</p> <p>FVBD3634 FVBD3934 FVBD42234 FVBD4534 FVBD4834</p>	<p>ITEM NUMBER</p> <p>VBT3621F4 VBT3921F4 VBT4221F4 VBT4521F4 VBT4821F4</p>
-----------------------------------	--	---	---	--



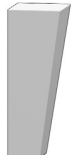

Furniture Utility Cabinet with Drawers

<p>18 W 80 H (F5) 21 D</p>		<ul style="list-style-type: none"> One door Three hinges per door Three drawers Drawer weight capacity: 75 lbs Dovetail drawers standard Soft close hinge and drawer upgrade available, see page 5 Three adjustable shelves Premium all wood package upgrade available 	<p>MODEL NUMBER</p> <p>UT1821F5</p> <p>ITEM NUMBER</p> <p>U3D1821F5</p>	
Furniture Vanity Height Codes		Furniture Vanities feature 4 Bunn feet or 4 Tapered feet that are installed during the production process.		
<p>F4 = 34½" Tall F5 = 80" Tall</p>	<p>Classic Harmony Vanderburgh Williamsburg</p> 		<p>Durham Georgetown Jamestown Kingston Mission Rentown Urbana Youngstown</p>	

All shelves and bottoms are rated to withstand 15 lbs. per square foot.

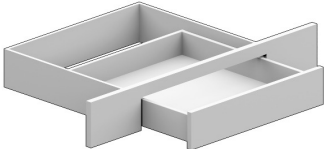
For additional cabinet options, please see page 5.

Specialty Cabinets

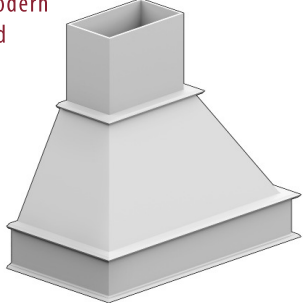
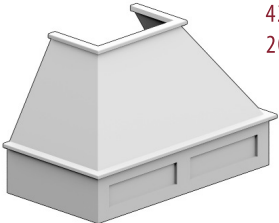
<p>Drawer 36 W 5 H 21 D</p> 	Under Mount Drawer		
<p>24 W 30 H 9 D</p> 	Over the John		
<p>12 or 21 W 30 H 6 or 8 D</p> 	Bathroom Wall Cabinet		
<p>Medicine Cabinet 15 W 20, 24 H 4 D</p> <p>Rough Opening: 14 W 19, 23 H</p> 	Wall Medicine Cabinet		
<p>Straight Modern Range Hood 36 W 42 H 20 D</p> 	36" Range Hood Cabinets		<p>Modern Range Hood 36 W 42 H 20 D</p>  <p>Shown without chimney</p>
<ul style="list-style-type: none"> • 250 cfm ventilation module with light included • Overall Width is 38⁵/₁₆" • Includes trimmable chimney • Maple, Oak, or Cherry available 	<p>MODEL NUMBER UDV36</p>	<p>ITEM NUMBER AUD362105</p>	<p>MODEL NUMBER OJ2430</p> <p>ITEM NUMBER WOJ243009</p>
<p>MODEL NUMBER BWC12306 BWC21308</p>	<p>ITEM NUMBER WBC123006 WBC213008</p>	<p>MODEL NUMBER WMC152004 WMC152404</p>	<p>ITEM NUMBER WMC152004 WMC152404</p>

All shelves and bottoms are rated to withstand 15 lbs. per square foot.



For additional cabinet options, please see page 5.

Accessories

What Not Shelves

Wall What Not (ASW) 12 W 30, 36, 42 H 6 D 	<ul style="list-style-type: none"> Available in 30, 36, and 42 H 12 W 6 D 	<ul style="list-style-type: none"> Wall What Not Shelf - three shelves 	
		MODEL NUMBER WNS30 WNS36 WNS42	ITEM NUMBER ASW123006E ASW123606E ASW124206E

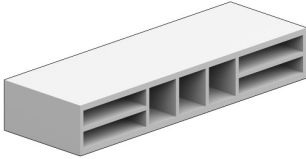
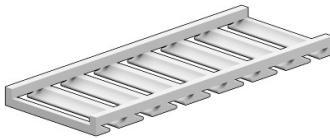
Under Mount Accessories

Organizer (AOR)  36 or 48 W x 6 H x 12 D	Wine Stem Holder (AWS)  30 or 36 W x 12 D	Bar Bracket (ABB)  8 H x 8 D
<ul style="list-style-type: none"> Four 2 x 10 trays Three 4½ x 4¼ compartments Horizontal install available 	MODEL NUMBER AWS30 AWS36	ITEM NUMBER AWS301202E AWS361202E
MODEL NUMBER ORG36 ORG48	ITEM NUMBER AOR360612E AOR480612E	<ul style="list-style-type: none"> Decorative support
		MODEL NUMBER BB8
		ITEM NUMBER ABB080803E

Valances

Arch (AVR)  Straight (AVS) 	<ul style="list-style-type: none"> Available in 36, 48, 56, 60 and 72 W 6 H 	MODEL NUMBER VA36 VA48 VA56 VA60 VA72	ITEM NUMBER AVR3606A6E AVR4806A6E AVR5606A6E AVR6006A6E AVR7206A6E
--	---	---	--

All shelves and bottoms are rated to withstand 15 lbs. per square foot.

For additional cabinet options, please see page 5.

Accessories

Mirrors

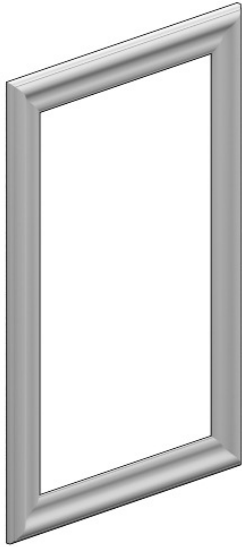

AMR (Standard)

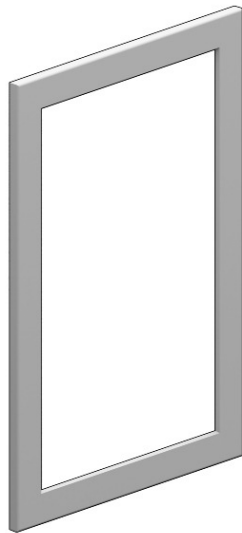

AMG (Shaker)

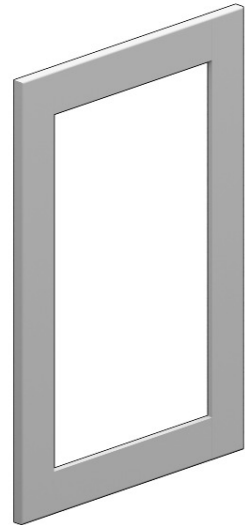

AMJ (Wide Shaker)

MODEL NUMBER
AMR2030A6E
AMR3636A6E

ITEM NUMBER
AMR2030A6E
AMR3636A6E

MODEL NUMBER
AMG2030A6E
AMG3636A6E

ITEM NUMBER
AMG2030A6E
AMG3636A6E

MODEL NUMBER
AMJ2030A6E
AMJ3636A6E

ITEM NUMBER
AMJ2030A6E
AMJ3636A6E



AMR Profile
(Standard) 2 1/2" Rail







AMG Profile
(Shaker) 2 3/16" Rail

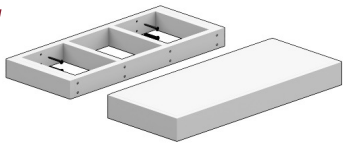

AMJ Profile
(Wide Shaker) 2 15/16" Rail

Available in either 20 x 30 or 36 x 36 - Mounting hardware is NOT included.

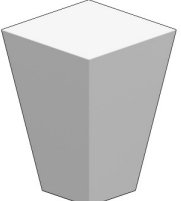
Accessories

<p>Floating Shelves: 24, 30, 36, 42, 48 W</p>  <p>Installation: Attach brackets to wall studs</p>	Floating Shelves		
<p>Bunn (ABU) (Left)</p>  <p>3 W 4½ H</p> <p>Tapered (ATL) (Right)</p> 	Feet - Bunn & Tapered		
<p>3 W (Left) 6 H 3 D</p>  <p>5 W (Right) 10 H 6 D</p> 	Corbels		
<ul style="list-style-type: none"> • 2½" thick, 10" deep • Supports 15 lbs per running foot of shelf length • Upon installation, attach brackets to wall studs 	<p>MODEL NUMBER</p> <p>FS24 FS30 FS36 FS42 FS48</p>	<p>ITEM NUMBER</p> <p>ASF102402E ASF103002E ASF103602E ASF104202E ASF104802E</p>	
<ul style="list-style-type: none"> • Fits under base cabinet toe kick 	<p>MODEL NUMBER</p> <p>FOOT_BU FOOT_TL</p>	<p>ITEM NUMBER</p> <p>ABU030304E ATL030304E</p>	
<ul style="list-style-type: none"> • Available in all finishes 	<p>MODEL NUMBER</p> <p>DC03 DC05</p>	<p>ITEM NUMBER</p> <p>ADC030306E ADC050610E</p>	

Organizers/Sales Kiosk

Wall Pull Out Organizers

Shown in 3" width
with Flat Filler
3 or 6 W
30 or 42 H
12 D

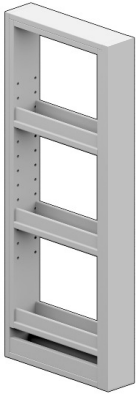

- Available in 3" or 6" W
- Available in 30" or 42" H
- Flat filler available (AWF)

MODEL NUMBER
WPOS3X30
WPOS6X30

ITEM NUMBER
AWF061230E
AWF031230E

Base Pull Out Organizer

Shown in 6" width
with Flat Filler
3 or 6 W
30 H
24 D



- Available in 3" or 6" W
- 30" H
- Flat filler available (ABF)

MODEL NUMBER
BPOS3X30
BPOS6X30

ITEM NUMBER
ABF062430E
ABF032430E

Wall Hanging Kiosk - 36 x 12 x 36

36 W
36 or 48 H
12 D



- 24 sample door capacity; specify sample doors, which door style, and finish of your preference
- Sample doors sold separately
- Door hanging hardware included

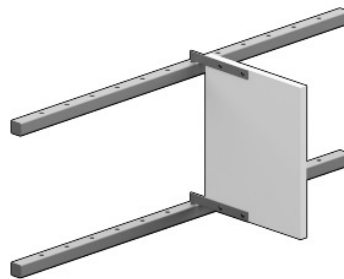

MODEL NUMBER
N/A
N/A

ITEM NUMBER
SKI361236
SKI361248



Sample Door Bracket Set

Fillers

Fillers																																								
<p>Filler (AFI) 3 or 6 W (Left - 6 W Shown)</p>			<ul style="list-style-type: none"> Available by the piece (P) or by the box (B) Filler Available in 3" or 6" W Corner Filler Face 3" W 3" W fillers come in boxes of 10 pieces 	<ul style="list-style-type: none"> 6" W fillers come in boxes of 5 pieces Available in 30", 42", 84", 90", and 96" H; boxes only available for 30" & 42" H Available in all finishes 																																				
<p>Corner Filler (ACN) 3 W (Right)</p>			<table border="1" style="width: 100%; border-collapse: collapse;"> <thead> <tr> <th style="width: 25%;">MODEL NUMBER</th> <th style="width: 25%;">ITEM NUMBER</th> <th style="width: 25%;">MODEL NUMBER</th> <th style="width: 25%;">ITEM NUMBER</th> </tr> </thead> <tbody> <tr> <td>CF3X3X30P</td> <td>ACN030330P</td> <td>F6X30P</td> <td>AFI0630A6P</td> </tr> <tr> <td>F3X30P</td> <td>AFI0330A6P</td> <td>F6X30B</td> <td>AFI0630A6B</td> </tr> <tr> <td>F3X30B</td> <td>AFI0330A6B</td> <td>F6X42P</td> <td>AFI0642A6P</td> </tr> <tr> <td>F3X42P</td> <td>AFI0342A6P</td> <td>F6X42B</td> <td>AFI0642A6B</td> </tr> <tr> <td>F3X42B</td> <td>AFI0342A6B</td> <td>F6X84P</td> <td>AFI0684A6P</td> </tr> <tr> <td>F3X84P</td> <td>AFI0384A6P</td> <td>F6X90P</td> <td>AFI0690A6P</td> </tr> <tr> <td>F3X90P</td> <td>AFI0390A6P</td> <td>F6X96P</td> <td>AFI0696A6P</td> </tr> <tr> <td>F3X96P</td> <td>AFI0396A6P</td> <td></td> <td></td> </tr> </tbody> </table>	MODEL NUMBER	ITEM NUMBER	MODEL NUMBER	ITEM NUMBER	CF3X3X30P	ACN030330P	F6X30P	AFI0630A6P	F3X30P	AFI0330A6P	F6X30B	AFI0630A6B	F3X30B	AFI0330A6B	F6X42P	AFI0642A6P	F3X42P	AFI0342A6P	F6X42B	AFI0642A6B	F3X42B	AFI0342A6B	F6X84P	AFI0684A6P	F3X84P	AFI0384A6P	F6X90P	AFI0690A6P	F3X90P	AFI0390A6P	F6X96P	AFI0696A6P	F3X96P	AFI0396A6P			
MODEL NUMBER	ITEM NUMBER	MODEL NUMBER	ITEM NUMBER																																					
CF3X3X30P	ACN030330P	F6X30P	AFI0630A6P																																					
F3X30P	AFI0330A6P	F6X30B	AFI0630A6B																																					
F3X30B	AFI0330A6B	F6X42P	AFI0642A6P																																					
F3X42P	AFI0342A6P	F6X42B	AFI0642A6B																																					
F3X42B	AFI0342A6B	F6X84P	AFI0684A6P																																					
F3X84P	AFI0384A6P	F6X90P	AFI0690A6P																																					
F3X90P	AFI0390A6P	F6X96P	AFI0696A6P																																					
F3X96P	AFI0396A6P																																							

Panels

1/4" Overlay End Panels					
<p>PBE: Base End Panel PVE: Vanity End Panel PWE: Wall End Panel PTE: Tall and Refrigerator Panel</p>	<ul style="list-style-type: none"> Made of veneer Color/finish on one side, raw on backside 1/4" thickness Painted finishes (laminated) 	<p>MODEL NUMBER</p>	<p>ITEM NUMBER</p>	<p>MODEL NUMBER</p>	<p>ITEM NUMBER</p>
		<p>BEP VEP WEP30 WEP36 WEP42</p>	<p>PBE2434A2E PVE2134A2E PWE1230A2E PWE1236A2E PWE1242A2E</p>	<p>WEP3015 WEP3615 WEP4215 TEP84 TEP96</p>	<p>PWE1530A2E PWE1536A2E PWE1542A2E PTE2484A2E PTE2496A2E</p>
Decorative End Panels					
<p>Decorative End Panel</p>  <p>(Shown in Williamsburg)</p>	<p>Base End Panels</p>				
	<ul style="list-style-type: none"> Available in all door styles 	<p>MODEL NUMBER</p>	<p>ITEM NUMBER</p>	<p>DESCRIPTION</p>	
		<p>RPEB2134 RPEB34</p>	<p>PDE2134A6E PDE2434A6E</p>	<p>20.25 x 34 DECORATIVE VAN END PANEL 23.25 X 34 DECORATIVE BASE END PANEL</p>	
	<ul style="list-style-type: none"> Standard overlay Available in Harmony, Georgetown, Youngstown, Vanderburgh, Classic 	<p>MODEL NUMBER</p>	<p>ITEM NUMBER</p>	<p>DESCRIPTION</p>	
		<p>RPEB2130 RPEB30</p>	<p>PDE2130A6E PDE2430A6E</p>	<p>19 x 27 DECORATIVE VAN END PANEL 22 x 27 DECORATIVE BASE END PANEL</p>	
	<ul style="list-style-type: none"> Full overlay Available in Durham, Jamestown, Kingston, Rentown, Urbana, Williamsburg 	<p>MODEL NUMBER</p>	<p>ITEM NUMBER</p>	<p>DESCRIPTION</p>	
		<p>RPEB2130 RPEB30</p>	<p>PDE2130A6E PDE2430A6E</p>	<p>20.25 X 29 DECORATIVE VAN END PANEL 23.25 X 29 DECORATIVE BASE END PANEL</p>	

Panels

Decorative End Panels

Wall End Panels

- Standard overlay
- Available in Classic, Georgetown, Harmony, Mission, Vanderburgh, Youngstown

- Full overlay
- Available in Durham, Jamestown, Kingston, Rentown, Urbana, Williamsburg

MODEL NUMBER	ITEM NUMBER	DESCRIPTION	MODEL NUMBER	ITEM NUMBER	DESCRIPTION
RPEW12	PDE1212A6E	10 x 9 DECORATIVE WALL END PANEL	RPEW12	PDE1212A6E	11.25 X 12 DECORATIVE WALL END PANEL
RPEW15	PDE1215A6E	10 x 12 DECORATIVE WALL END PANEL	RPEW15	PDE1215A6E	11.25 X 14 DECORATIVE WALL END PANEL
RPEW18	PDE1218A6E	10 x 15 DECORATIVE WALL END PANEL	RPEW18	PDE1218A6E	11.25 X 17 DECORATIVE WALL END PANEL
RPEW21	PDE1221A6E	10 x 18 DECORATIVE WALL END PANEL	RPEW21	PDE1221A6E	11.25 X 20 DECORATIVE WALL END PANEL
RPEW24	PDE1224A6E	10 x 21 DECORATIVE WALL END PANEL	RPEW24	PDE1224A6E	11.25 X 23 DECORATIVE WALL END PANEL
RPEW27	PDE1227A6E	10 x 24 DECORATIVE WALL END PANEL	RPEW27	PDE1227A6E	11.25 X 26 DECORATIVE WALL END PANEL
RPEW30	PDE1230A6E	10 x 27 DECORATIVE WALL END PANEL	RPEW30	PDE1230A6E	11.25 X 29 DECORATIVE WALL END PANEL
RPEW36	PDE1236A6E	10 X 33 DECORATIVE WALL END PANEL	RPEW36	PDE1236A6E	11.25 X 35 DECORATIVE WALL END PANEL
RPEW42	PDE1242A6E	10 x 39 DECORATIVE WALL END PANEL	RPEW42	PDE1242A6E	11.25 X 41 DECORATIVE WALL END PANEL
RPEW1518	PDE1518A6E	13 X 15 DECORATIVE WALL END PANEL	RPEW1518	PDE1518A6E	14.25 X 17 DECORATIVE WALL END PANEL
RPEW1530	PDE1530A6E	13 x 27 DECORATIVE WALL END PANEL	RPEW1530	PDE1530A6E	14.25 X 29 DECORATIVE WALL END PANEL
RPEW1536	PDE1536A6E	13 X 33 DECORATIVE WALL END PANEL	RPEW1536	PDE1536A6E	14.25 X 35 DECORATIVE WALL END PANEL
RPEW1542	PDE1542A6E	13 X 39 DECORATIVE WALL END PANEL	RPEW1542	PDE1542A6E	14.25 X 41 DECORATIVE WALL END PANEL
RPEW2412	PDE2412A6E	22 X 9 DECORATIVE WALL END PANEL	RPEW2412	PDE2412A6E	23.25 X 11 DECORATIVE WALL END PANEL
RPEW2415	PDE2415A6E	22 X 12 DECORATIVE WALL END PANEL	RPEW2415	PDE2415A6E	23.25 X 14 DECORATIVE WALL END PANEL
RPEW2418	PDE2418A6E	22 X 15 DECORATIVE WALL END PANEL	RPEW2418	PDE2418A6E	23.25 X 17 DECORATIVE WALL END PANEL
RPEW2421	PDE2421A6E	22 x 18 DECORATIVE WALL END PANEL	RPEW2421	PDE2421A6E	23.25 X 20 DECORATIVE WALL END PANEL
RPEW2424	PDE2424A6E	22 X 21 DECORATIVE WALL END PANEL	RPEW2424	PDE2424A6E	23.25 X 23 DECORATIVE WALL END PANEL

Panel with Edge Banding

- Edge Banding: Thin layer of veneer applied along the sides of panel
- Matches finish of cabinet
- Available in End Panel or Refrigerator Panel
- Painted finishes (laminated)

Edge banding:	MODEL NUMBER	ITEM NUMBER
2 Edges	BEP34X.75 REP48X96X.75	PMV2434A6E PMV4896A6E
1 Edge	REP96X.75	PMV2496A6E

Panel with Filler

Dishwasher End Panel



(shown with 3" filler)

- Refer Panel with Filler: 3/8" thick
- Dishwasher Panel with Filler available with 1 1/2", 3", or 6" filler
- Wall and Refer Panels with Fillers available with 1 1/2" and 3" filler
- Panel with filler gets cleats on three sides
- Premium all wood package upgrade available

MODEL NUMBER	ITEM NUMBER	MODEL NUMBER	ITEM NUMBER
DWP1.5	APD012434E	REP1.596	APF012496E
DWP3	APD032434E	REP1.53084	APF013084E
DWP6	APD062434E	REP1.53096	APF013096E
APW1.5	APW011230E	REP384	APF032484E
APW1.5	APW011242E	REP396	APF032496E
APW3	APW031230E	REP33084	APF033084E
APW3	APW031242E	REP33090	APF033090E
REP1.584	APF012484E	REP33096	APF033096E

APD: Dishwasher Panel with Filler
 APW: Wall Panel with Filler
 APF: Refer Panel with Filler

Finished 4 x 8 Panels

Regular Grain



Cross Grain



Bead Board

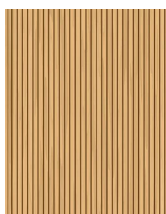

- Made of veneer
- Finished on one side, raw on backside
- Cross grain or regular grain available
- Painted finishes laminated



MODEL NUMBER	ITEM NUMBER
PANEL-34	PAN4834A2E
PANEL-96	PAN4896A2E
PANEL-OC	PCG4896A2E
PANEL-OB	PBB4896A2E

PAN: 1/4" x 48 x 96 Regular Grain Panel
 PCG: 1/4" x 96 x 48 Cross Grain Panel
 PBB(A2): 1/4" x 48 x 96 Bead Board Panel

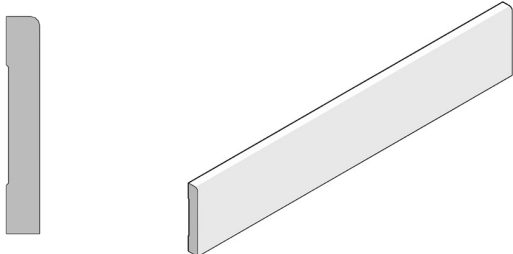
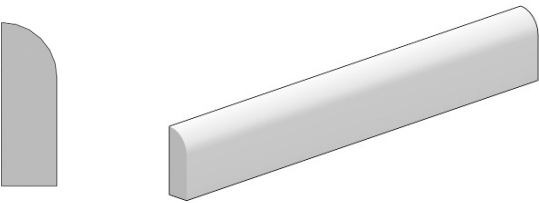
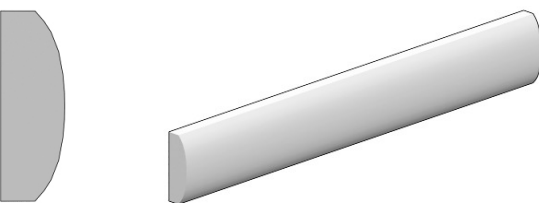
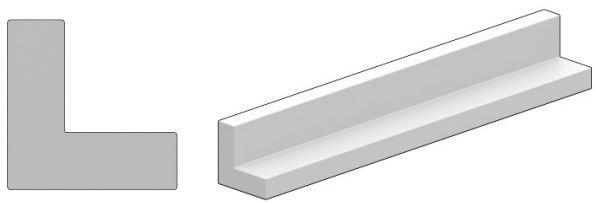
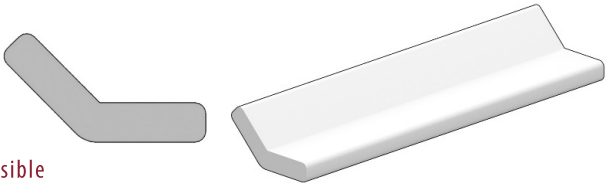
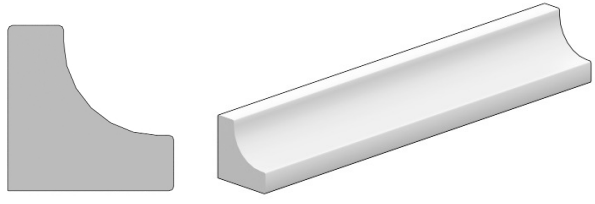
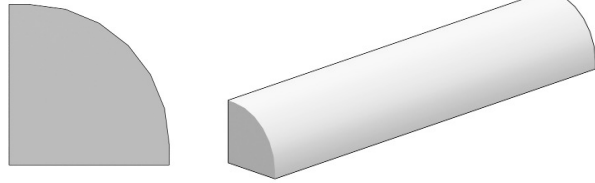
Moldings

Moldings			
	Furniture Base		
	<ul style="list-style-type: none"> • 3/4" x 4 7/16" • Available by the piece (P) or in boxes (B) (4 in a box) • Not finished on back; available in all finishes 	MODEL NUMBER BSM4 BSM4B	ITEM NUMBER MBS45A6P MBS45A6B
	Scribe		
	<ul style="list-style-type: none"> • 1/4" x 3/4" • Available by the piece (P) or in boxes (B) (12 in a box) • Not finished on the back; available in all finishes 	MODEL NUMBER SM8 SM8B	ITEM NUMBER MSC08A6P MSC08A6B
	Batten		
	<ul style="list-style-type: none"> • 1/4" x 3/4" • Available by the piece (P) or in boxes (B) (12 in a box) • Not finished on the back; available in all finishes 	MODEL NUMBER BM8 BM8B	ITEM NUMBER MBT08A6P MBT08A6B
	Outside Corner		
	<ul style="list-style-type: none"> • 1/4" x 3/4" • Available by the piece (P) or in boxes (B) (12 in a box) • Not finished on the back; available in all finishes 	MODEL NUMBER OSC8 OSC8B	ITEM NUMBER MOC08A6P MOC08A6B
 <p>Reversible</p>	135 Degree Angle Corner		
	<ul style="list-style-type: none"> • 1 1/4" x 1/4" • Available by the piece (P) or in boxes (B) (12 in a box) • Finished on all sides; available in all finishes 	MODEL NUMBER ACM8 ACM8B	ITEM NUMBER MAC08A6P MAC08A6B
	Inside Corner		
	<ul style="list-style-type: none"> • 1/4" x 3/4" • Available by the piece (P) or in boxes (B) (12 in a box) • Not finished on the back; available in all finishes 	MODEL NUMBER ISC8 ISC8B	ITEM NUMBER MIC08A6P MIC08A6B
	Quarter Round		
	<ul style="list-style-type: none"> • 3/4" x 3/4" • Available by the piece (P) or in boxes (B) (12 in a box) • Not finished on the back; available in all finishes 	MODEL NUMBER QRM8 QRM8B	ITEM NUMBER MQR08A6P MQR08A6B

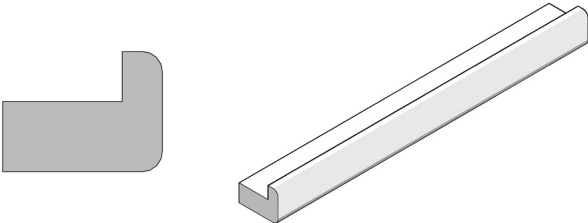
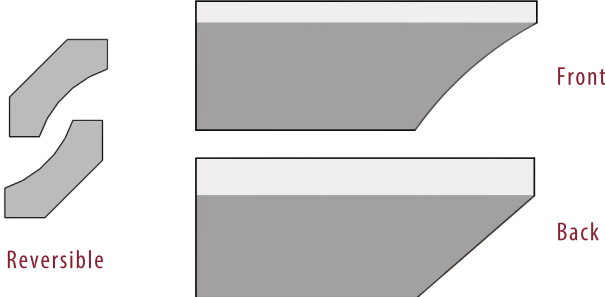
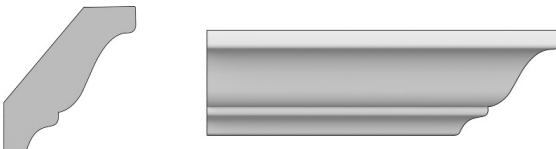
Moldings

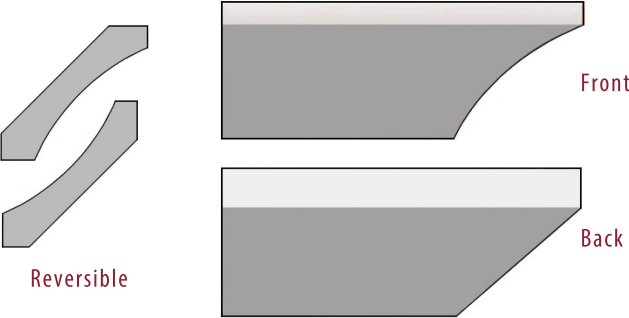
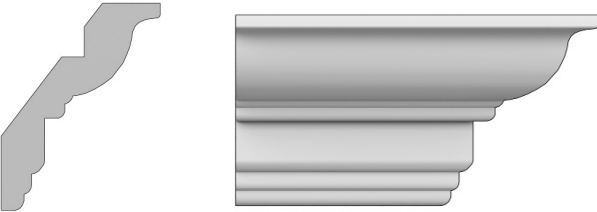
		Under Cabinet	
		<ul style="list-style-type: none"> • 3/4" x 1 1/8" • Available by the piece (P) or in boxes (B) (12 in a box) • Not finished on the back; available in all finishes 	MODEL NUMBER UM1 UM1B
		1 3/4" Reversible Cove Molding	
		<ul style="list-style-type: none"> • 1 1/8" installed height • 1/4" protrusion from cabinet face • Available by the piece (P) or in boxes (B) (8 in a box) • Not finished on the back; available in all finishes 	MODEL NUMBER RCM1 RCM1B
		2 1/4" Crown Molding	
		<ul style="list-style-type: none"> • 1 7/8" installed height • 1 7/8" protrusion from cabinet face • Available by the piece (P) or in boxes (B) (8 in a box) • Not finished on the back; available in all finishes 	MODEL NUMBER CM2 CM2B
		3 1/4" Reversible Cove Molding	
		<ul style="list-style-type: none"> • 2 3/16" installed height • 2 3/8" protrusion from cabinet face • Available by the piece (P) or in boxes (B) (4 in a box) • Available in all finishes 	MODEL NUMBER RCM3 RCM3B
		4 1/4" Reversible Cove Molding	
		<ul style="list-style-type: none"> • 2 7/8" installed height • 3 1/8" protrusion from cabinet face • Available by the piece (P) or in boxes (B) (4 in a box) • Available in all finishes 	MODEL NUMBER RCM4 RCM4B
		4" Crown Molding	
		<ul style="list-style-type: none"> • 3 3/16" installed height • 2 7/16" protrusion from cabinet face • Available by the piece (P) or in boxes (B) (4 in a box) • Not finished on the back; available in all finishes 	MODEL NUMBER CM4 CM4B





Kountry Wood Products Limited Lifetime and Five-Year Warranty

Kountry Wood cabinets have been manufactured under the highest standards of quality and workmanship.

Lifetime Limited Warranty on Drawer Guides and Hinges

Kountry Wood Products warrants to original consumer purchasers for as long as they own their home that the drawer, drawer guides and hinges used in the manufacture of Kountry Wood Products cabinetry products shall be free from defects in material and workmanship under normal use.

Five Year Limited Warranty on Cabinets

In addition, Kountry Wood Products warrants to original consumer purchasers for a period of five-years from the original date of purchase that all other components of Kountry Wood Products cabinetry shall be free from defects in material and workmanship under normal use.

General Warranty Guidelines

Opaque Finishes are uniquely different from standard wood finishes. On all wood products, expansion and contraction are typical due to changes in climate conditions. Due to this normal movement, Opaque Finishes may develop slight separation lines, finish breaks and seam lines. These will be most notable at stile, rail and panel joints. Joint separations may become more noticeable over time and through season changes. These are normal and are not considered quality defects. Should Kountry Wood Products cabinetry fail during the applicable warranty period due to defects in the material or workmanship under normal use, Kountry Wood Products, at its discretion, will repair or provide the parts necessary to replace the defective products. This warranty does not cover products that are misused, abused, mishandled, improperly installed, improperly stored, changed, modified or subject to extreme temperatures or extreme moisture levels. This warranty is not valid for products used for any purpose other than the purpose for which they were originally intended. This warranty does not cover the cost of installation, removal, subsequent damage or transportation of the defective product, regardless of whether the work was performed by a contractor, service company or the consumer. Variations in color and grain pattern are a natural characteristic of wood. Color changes also may result from exposure to light and other elements that are part of the aging process. These material variations and changes are not covered by this warranty. Kountry Wood Products reserves the right to substitute discontinued product with the most similar product in styling, wood species and color available at the time a claim is submitted.

This warranty is the exclusive warranty of Kountry Wood Products and is in lieu of all other warranties, expressed or implied. In no event shall Kountry Wood Products be liable for consequential, indirect or incidental damages resulting from the installation, use or failure of its product. Some states do not allow the exclusion or limitation of incidental or consequential damages, so the above limitations or exclusions may not apply to you. This warranty gives you specific legal rights and you may also have other rights that vary from state to state. To submit a claim under this warranty, contact your nearest Kountry Wood Products dealer or send a letter explaining the defect along with a dated sales receipt as proof of purchase to:

Kountry Wood Products

352 Shawnee St - Nappanee, IN 46550

Revision A.1
Published January 2024

AMERICAN MADE CABINETRY

Discover the Differences
Experience the Beauty
Enjoy all the Options

**Kountry
WOOD**

CABINETS WORTH OWNING

352 Shawnee St. - Nappanee, IN 46550

Toll Free: 1-888-608-8969

Phone: 574-773-5673

Fax: 574-773-7013

www.kountrywood.com



ANSI/KCMA A161.1



KITCHEN CABINET MANUFACTURERS ASSOCIATION
ENVIRONMENTAL STEWARDSHIP PROGRAM (ESP)
ALL PRODUCTS IMPACT THE ENVIRONMENT
FOR ESP PROGRAM CRITERIA, VISIT KCMA.ORG