

# Kountry WOOD

CABINETS WORTH OWNING



## 2024 PRODUCT SPECIFICATIONS

HANDICAP & HANDICAP ACCESSIBLE CABINETS

# Kountry WOOD

CABINETS WORTH OWNING

Thank you for considering Kountry Wood Products for your cabinetry needs.

For 25 years, Kountry Wood has been manufacturing stock kitchen and bathroom cabinetry in Nappanee, Indiana - The Heartland of America. We are a family-owned business that values the heritage of our country.

Our business was founded on the basic philosophy of building a quality product, selling it at a reasonable price and providing excellent customer service.

We take our business seriously by providing American workers jobs in our community and by purchasing material from local suppliers. We are certified by the KCMA Environmental Stewardship Program, and reviewed annually to meet or exceed standards of air quality, product resource management and environmental stewardship to ensure a sustainable product for years to come.

We hope that you find our products to be the right choice for you.

Sincerely,

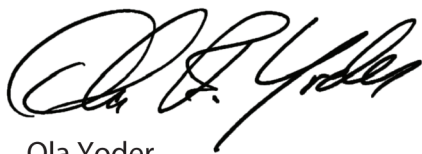

Ola Yoder  
CEO



# Table of Contents

Cabinet Care.....	2
Wood and Paint.....	3
Part Number - SKU Nomenclature .....	3
Cabinet Options.....	4
Finish Options.....	5
Product Matrix.....	6
Door Styles.....	8
Cabinet Specifications .....	15
Cabinet Dimensions .....	16
Base Cabinets.....	20
Blind Cabinets.....	23
Removable Sink Bases/Oven Cabinets .....	24
Utility Cabinets.....	25
Shelf Kits .....	26
Vanity Cabinets .....	27
Toe Kicks and Panels.....	30
Warranty .....	31

## Cabinet Care

Quality wood cabinet finishes that have been made to last, can, like good clothes, very quickly get a “used” appearance. Good things need looking after if they are to keep their quality. Due to its many properties, wood has always been a popular material for fine cabinetry the world over. Each tree is an individual piece of nature, which, after being felled, keeps its own character in its strength, structure and sensitivity to light and moisture. Wood can also change its character with time.

Moisture is the worst enemy of all wooden furniture, so all spilled liquids should be wiped away at once. Cabinets should be protected against heat, and also against wet or colored objects.

Cabinet surfaces should be cleaned with a very mild soapy solution. The cloth should be soft and dampened with the soap solution. The surface should then be wiped down with a dry cloth to remove excess moisture. Other cleaning compounds exist but may contain alkaline reagents which will adversely affect the surface. Household polishes can be used on an infrequent basis. Products containing silicone are moisture and dirt resistant but may hinder future lacquering.



KITCHEN CABINET MANUFACTURERS ASSOCIATION.  
ENVIRONMENTAL STEWARDSHIP PROGRAM (ESP).  
ALL PRODUCTS IMPACT THE ENVIRONMENT  
FOR ESP PROGRAM CRITERIA, VISIT [KCMA.ORG](http://KCMA.ORG)



KITCHEN CABINET  
MANUFACTURERS ASSOCIATION™



## Wood and Paint

### Characteristics & Variations

**Wood** - Naturally occurring variations in wood such as color, grain, mineral streaks and knots are not considered defects.

Color variations are a natural occurrence due to species, age, character of cabinets, and exposure to UV light and sunlight. Such variations and changes are not considered defects. For these reasons, new and/or replacement cabinets may not match display samples and/or existing cabinets.

Warping is the bending or twisting of a part. To measure a door or shelf, lay the product on a flat surface and measure the gap from the surface to the part. The standard allowable tolerance for wood is  $\frac{1}{8}$ " per lineal foot. Materials that fall within specification are considered acceptable, as a part of the natural characteristics of wood.

**Paint Finishes** - Paint finishes are uniquely different from standard wood finishes. On all wood products, expansion and contraction are typical due to changes in climate conditions. Due to this normal movement, paint finishes may develop slight separation lines, finish breaks and seam lines. These will be most notable at stile, rail and panel joints. Joint separations may become more noticeable over time and through season changes.

With the use of select hardwoods and veneers, some of the grain pattern and wood characteristics (checks & pin knots) as well as seams & joints will remain visible through the paint finish. These are normal and are not considered quality defects.

Seam lines and finish breaks are normal characteristics of paint finishes and should not be considered a reason for product replacement. Over time, there may be a slight color shift, due to exposure to natural and artificial light.

Part Number - SKU Nomenclature								
	----- ITEM NUMBER -----				Door Style	Door Option	Color Species	Cabinet Options
	Cabinet Type	Cabinet Width	Cabinet Depth	Cabinet Height *				
CHARACTERS	1-3	4-5	6-7	8-9	10-11	12-13	14-16	17-22
EXAMPLE	BAS	30	24	HH	GX	01	STX	V
BAS3024HHGX01STXV - Base 30" [BAS3024HH], Georgetown [GX], Butt Doors [01], Slate [STX], Premium & Plywood Veneer [V]								

\* Cabinet Height (chars 8-9): Tall (2 digits), Handicap (HH), or Handicap Accessible (HA)

Door Style Codes					
CX = Classic	DX = Durham	GX = Georgetown	HX = Harmony	JX = Jamestown	KX = Kingston
MX = Mission	RX = Rentown	UX = Urbana	VX = Vanderburgh	WX = Williamsburg	YX = Youngstown

Color Species Codes				
CHERRY/STAINED	MAPLE/STAINED		OAK/STAINED	HDF/PAINTED
LXX = Lava	ABX = Auburn	PCX = Pecan	CBX = Cobblestone	LSX = Limestone
	CFX = Coffee	STX = Slate	DWX = Driftwood	PEX = Pearl
	NXX = Natural	SSX = Sandstone	FXX = Fairfield	WHX = White
	ONX = Onyx	TFX = Toffee	KXX = Kountry	

## Cabinet Options

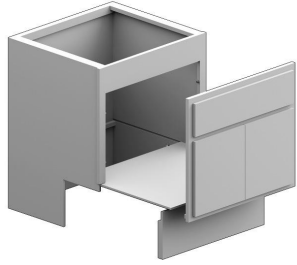
OPTION	DESCRIPTION		
02	FULL HEIGHT DOOR: BASE CABINETS ONLY		
03	GLASS DOOR PREP <ul style="list-style-type: none"> <li>TOP DOOR(S) ONLY on UHC, UAC Utilities</li> <li>N/A on UH2, UA3 Utilities, or Base Cabinets</li> </ul>	<p style="text-align: center;">Removable Cabinet Front</p> 	
05	MULLION DOOR (SEE DOOR CONSTRUCTION SPECIFICATIONS FOR IMAGES)		SINGLE DOOR CABINET (<= 24" W)
			2 OR 4 DOOR CABINET (>=27" W)
100	3/4" MDF SHELF: AVAILABLE ON STANDARD CONSTRUCTION ONLY		
102	3/4" PLYWOOD SHELF: [Handicap Accessible Bases & Vanities ONLY]		
VM	MATCHING INTERIOR (M): [STAIN FINISHES ONLY] - REQUIRES PREMIUM AND PLYWOOD VENEER [V]		
DI	MATCHING PAPER INTERIOR (I): [Limestone, Pearl ONLY] - REQUIRES PREMIUM (D)		
BRF, VRF	REMOVABLE FRONT CABINET: (SEE IMAGE AT RIGHT) <ul style="list-style-type: none"> <li>AVAILABLE ONLY ON SINK BASES AND VANITY SINK BASES</li> <li>REPLACE "BSB" or "VSB" PREFIXES WITH "BRF" or "VRF"</li> <li><b>NOTE:</b> SIZES UNDER 33" WIDE MAY NOT ALLOW WHEELCHAIR ACCESS</li> </ul>		

### SOFT CLOSE OPTIONS \* BOTH OPTIONS NEED TO BE SELECTED FOR THE SOFT CLOSE PACKAGE \*

OPTION	DESCRIPTION
28	SOFT CLOSE HINGES <ul style="list-style-type: none"> <li>DOORS WITH 2 HINGES RECEIVE 1 SOFT CLOSE HINGE. (<b>EXCEPTION:</b> DOORS LARGER THAN 17" X 21" RECEIVE 2 SOFT CLOSE HINGES)</li> <li>DOORS WITH 3 HINGES RECEIVE 2 SOFT CLOSE HINGES.</li> </ul>
S	SOFT CLOSE WOOD DRAWERS (FULL EXTENSION) <ul style="list-style-type: none"> <li>NOT AVAILABLE IN 18" DEEP VANITIES</li> </ul>

OPTION	DESCRIPTION
W	ALL WOOD DRAWER BOX: INCLUDED ON CABINETS 27" - 36" W
06	5 PIECE DRAWER OPTION: NOT AVAILABLE ON DURHAM OR MISSION

PREFIX	DESCRIPTION
ROS	ROLL OUT SHELF FOR BASE CABINET *75LBS WEIGHT CAPACITY* FACTORY INSTALLATION OPTION <ul style="list-style-type: none"> <li>1 Level: Tray(s) installed at the bottom of the cabinet.</li> <li>2 Levels: 1st level of tray(s) installed at the bottom of the cabinet. 2nd level of tray(s) spaced evenly above.</li> </ul>
ROSU	ROLL OUT SHELF FOR UTILITY CABINET *75LBS WEIGHT CAPACITY* FACTORY INSTALLATION OPTION (For each level of shelving, 1 tray is installed per door opening.) <ul style="list-style-type: none"> <li>2 Levels: 1st level of tray(s) installed at the bottom of the cabinet. 2nd level of tray(s) spaced evenly above (21" space).</li> <li>4 Levels: 1st level of tray(s) installed at the bottom of the cabinet. 2nd - 4th level of tray(s) spaced evenly above. (10" space).</li> </ul>

OPTION	DESCRIPTION
P	PLYWOOD VENEER SIDES: Not available on painted cabinets
V	PLYWOOD VENEER SIDES: Use with Premium Option - Not available on painted cabinets

Maple.....

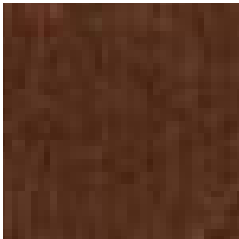

Auburn

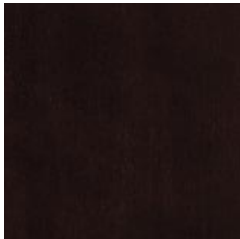

Coffee



Natural



Onyx



Toffee

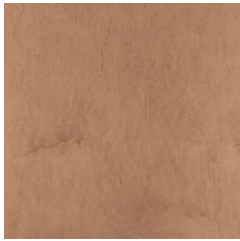

Pecan



Slate

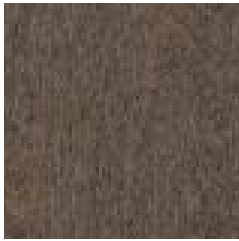

Sandstone

Painted.....



Pearl

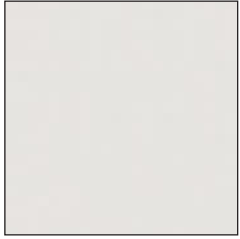

White



Limestone

Oak.....



Cobblestone



Driftwood

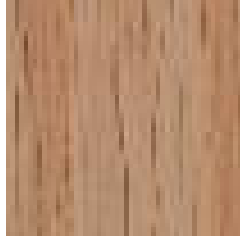

Fairfield



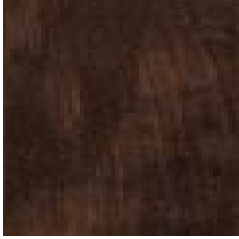

Kountry

Cherry.....



Lava

Note: Colors may not accurately be represented due to variations in the printing process. Please request a sample from your dealer.

Product Matrix						
Price Column ▶	A			B		
Door Style ▶	Harmony	Mission	Durham Full Overlay Only	Georgetown	Youngstown	Vanderburgh
Finish & Species ▼						
	FLAT PANEL (5-Piece Drawer Optional)	SLAB	SLAB	SHAKER (5-Piece Drawer Optional)	SHAKER FLAT PANEL (5-Piece Drawer Optional)	MITERED FLAT PANEL (5-Piece Drawer Optional)
Auburn Maple	✓	✓	✓	✓	✓	✓
Coffee Maple	✓	✓	✓	✓	✓	✓
Natural Maple	✓	✓	✓	✓	✓	✓
Onyx Maple	✓	✓	✓	✓	✓	✓
Pecan Maple	✓	✓	✓	✓	✓	✓
Sandstone Maple	✓	✓	✓	✓	✓	✓
Slate Maple	✓	✓	✓	✓	✓	✓
Toffee Maple	✓	✓	✓	✓	✓	✓
Lava Cherry	✓			✓	✓	✓
Cobblestone Oak	✓			✓	✓	
Fairfield Oak	✓			✓	✓	
Kountry Oak	✓			✓	✓	
Driftwood Oak	✓			✓	✓	
Painted Limestone*† (Elegant Maple Interior)		✓	✓	✓	✓	✓ Maple
Painted Pearl*† (Elegant Maple Interior)		✓	✓	✓	✓	✓ Maple
Painted White*† (White Interior)		✓	✓	✓	✓	✓ Maple







✓ Finish Available in Door Style

\* Additional charges apply

NOTE: Plywood Veneer Sides N/A in White, Limestone, or Pearl

† Composite Board on Painted Except as Noted



Product Matrix						
Price Column ▶	C		D			E
Door Style ▶	Kingston Full Overlay Only	Urbana Full Overlay Only	Classic	Jamestown Full Overlay Only	Rentown Full Overlay Only	Williamsburg Full Overlay Only
Finish & Species ▼						
	SHAKER (5-Piece Drawer Optional)	NARROW SHAKER (5-Piece Drawer Optional)	RAISED PANEL (5-Piece Drawer Optional)	WIDE RAIL SHAKER (5-Piece Drawer Optional)	WIDE RAIL FLAT PANEL (5-Piece Drawer Optional)	MITERED RAISED PANEL (5-Piece Drawer Optional)
Auburn Maple	✓	✓	✓	✓	✓	✓
Coffee Maple	✓	✓	✓	✓	✓	✓
Natural Maple	✓	✓	✓	✓	✓	✓
Onyx Maple	✓	✓	✓	✓	✓	✓
Pecan Maple	✓	✓	✓	✓	✓	✓
Sandstone Maple	✓	✓	✓	✓	✓	✓
Slate Maple	✓	✓	✓	✓	✓	✓
Toffee Maple	✓	✓	✓	✓	✓	✓
Lava Cherry	✓		✓	✓		✓
Cobblestone Oak	✓		✓	✓		
Fairfield Oak	✓		✓	✓		
Kountry Oak	✓		✓	✓		
Driftwood Oak	✓		✓	✓		
Painted Limestone*† (Elegant Maple Interior)	✓	✓		✓	✓	
Painted Pearl*† (Elegant Maple Interior)	✓	✓		✓	✓	
Painted White*† (White Interior)	✓	✓		✓	✓	

✓ Finish Available in Door Style

\* Additional charges apply

NOTE: Plywood Veneer Sides N/A in White, Limestone, or Pearl

† Composite Board on Painted Except as Noted

## Harmony

Flat Panel

**Construction:**

3/4" x 2 1/4" solid wood rails with mortise and tenon corner joints.

Available in standard overlay only

**Center panel:**

1/4" veneer

Rubber balls stabilize panel and allow for wood expansion and contraction

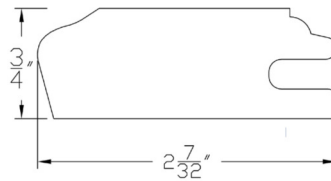

Door Profile



Standard Drawer Front

\*Edge detail on drawer front matches profile.



Optional 5-piece Drawer Front

## Mission

Slab

**Construction:**

5/8" particle board with maple veneer

Painted finishes: composite board

Available in standard overlay only

**Edges:**

Banded with a maple veneer

Optional 5-piece Drawer Front not available



Standard Drawer Front

## Durham

Slab

**Construction:**

5/8" particle board with maple veneer

Painted finishes: composite board

Available in full overlay only

**Edges:**

Banded with a maple veneer

Optional 5-piece Drawer Front not available



Standard Drawer Front

## Georgetown

Shaker

**Construction:**

3/4" x 2 1/4" solid wood rails with mortise and tenon corner joints

Painted finishes: composite board

Available in standard overlay only

**Center panel:**

1/4" veneer

Rubber balls stabilize panel and allow for wood expansion and contraction

Painted finishes: composite board

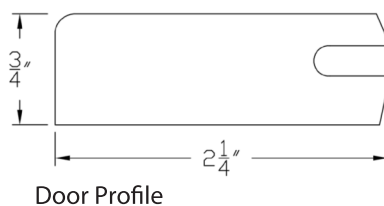

Standard Drawer Front

\*Edge detail on drawer front matches profile.

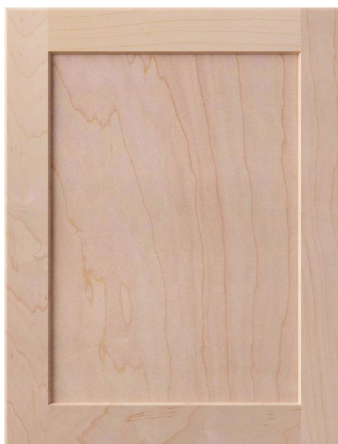

Optional 5-piece Drawer Front

# Youngstown

Flat Panel

**Construction:**

3/4" x 2 1/4" solid wood rails with mortise and tenon corner joints

Painted finishes: composite board

Available in standard overlay only

**Center panel:**

1/4" veneer

Rubber balls stabilize panel and allow for wood expansion and contraction

Painted finishes: composite board

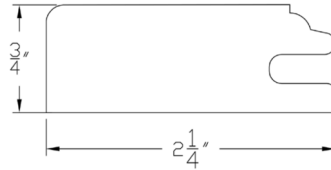

Door Profile



Standard Drawer Front

\*Edge detail on drawer front matches profile.



Optional 5-piece Drawer Front

# Vanderburgh

Mitered Flat Panel

**Construction:**

3/4" x 2 1/4" solid wood rails with mortise and tenon corner joints

Available in standard overlay only

**Center panel:**

1/4" veneer

Rubber balls stabilize panel and allow for wood expansion and contraction

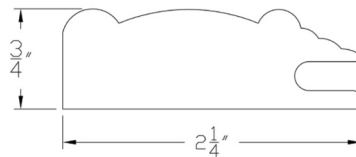

Door Profile



Standard Drawer Front



Standard Drawer Profile



Optional 5-piece Drawer Front

## Kingston

Shaker

### Construction:

$\frac{3}{4}$ " x  $2\frac{1}{4}$ " solid wood rails with mortise and tenon corner joints

Painted finishes: composite board

Available in full overlay only

### Center panel:

$\frac{1}{4}$ " veneer

Rubber balls stabilize panel and allow for wood expansion and contraction

Painted finishes: composite board

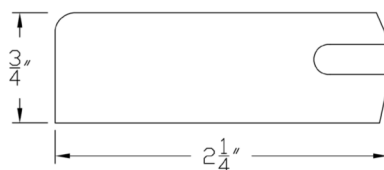

Door Profile



Standard Drawer Front

\*Edge detail on drawer front matches profile.

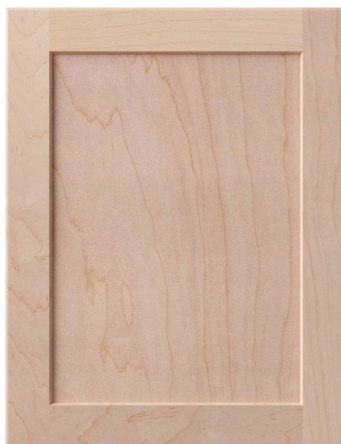

Optional 5-piece Drawer Front

## Urbana

Narrow Shaker

### Construction:

$\frac{3}{4}$ " x 2" solid wood rails with mortise and tenon corner joints

Painted finishes: composite board

Available in full overlay only

### Center panel:

$\frac{1}{4}$ " veneer

Center panels are held in place using glue in both the HDF and Maple

Painted finishes: composite board

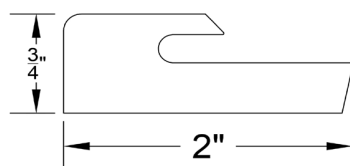

Door Profile



Standard Drawer Front

\*Edge detail on drawer front matches profile.



Optional 5-piece Drawer Front

# Classic

Raised Panel

**Construction:**

3/4" x 2 1/4" solid wood rails with mortise and tenon corner joints

Available in standard overlay only

**Center panel:**

5/8" solid oak, solid cherry or maple veneer on fiberboard

Rubber balls stabilize panel and allow for wood expansion and contraction

**5-piece Drawer Front:**

Raised Panel: Greater than 8 3/8" height

Flat Panel: Less than 8 3/8" height

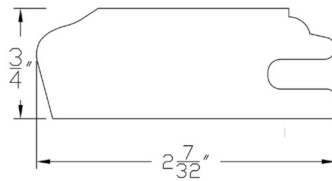

Door Profile



Standard Drawer Front

\*Edge detail on drawer front matches profile.



Optional 5-piece Drawer Front

# Jamestown

Wide Rail Shaker

**Construction:**

3/4" x 3" solid wood rails with mortise and tenon corner joints.

Painted finishes: composite board

Available in full overlay only

**Center panel:**

1/4" veneer

Rubber balls stabilize panel and allow for wood expansion and contraction.

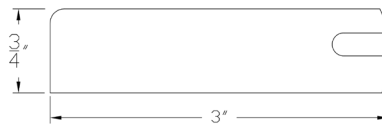

Door Profile



Standard Drawer Front

\*Edge detail on drawer front matches profile.



Optional 5-piece Drawer Front

(2 1/4" horizontal rail, 3" vertical rail)

## Rentown

Wide Rail Flat Panel

### Construction:

$\frac{3}{4}$ " x 3" solid wood rails with mortise and tenon corner joints

Painted finishes: composite board

Available in full overlay only

### Center panel:

$\frac{1}{4}$ " veneer

Rubber balls stabilize panel and allow for wood expansion & contraction

Painted finishes: composite board

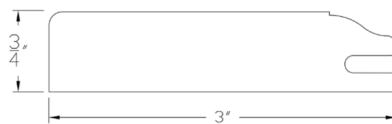

Door Profile



Standard Drawer Front  
\*Edge detail on drawer front matches profile.



Optional 5-piece Drawer Front  
( $1\frac{3}{4}$ " horizontal rail, 3" vertical rail)

## Williamsburg

Mitered Raised Panel

### Construction:

$\frac{3}{4}$ " x  $2\frac{1}{4}$ " solid wood rails with mortise and tenon corner joints

Available in full overlay only

### Center panel:

$\frac{5}{8}$ " solid wood

Rubber balls stabilize panel and allow for wood expansion and contraction

### 5-piece Drawer Front:

Raised Panel: Greater than  $8\frac{3}{8}$ " height

Flat Panel: Less than  $8\frac{3}{8}$ " height

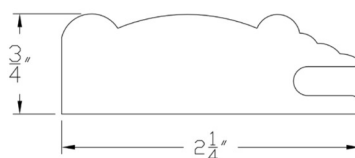

Door Profile



Standard Drawer Front



Standard Drawer Profile



Optional 5-piece Drawer Front

## Mullion

Available on wall cabinets and top doors of UHC and UHB only



**Available In:**

- Classic
- Georgetown
- Harmony
- Jamestown
- Kingston
- Rentown
- Youngstown



**Available In:**

- Vanderburgh
- Williamsburg



## Handicap Base Cabinet Specifications - STANDARD & PREMIUM

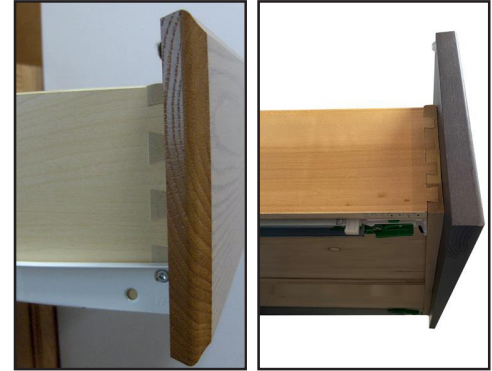
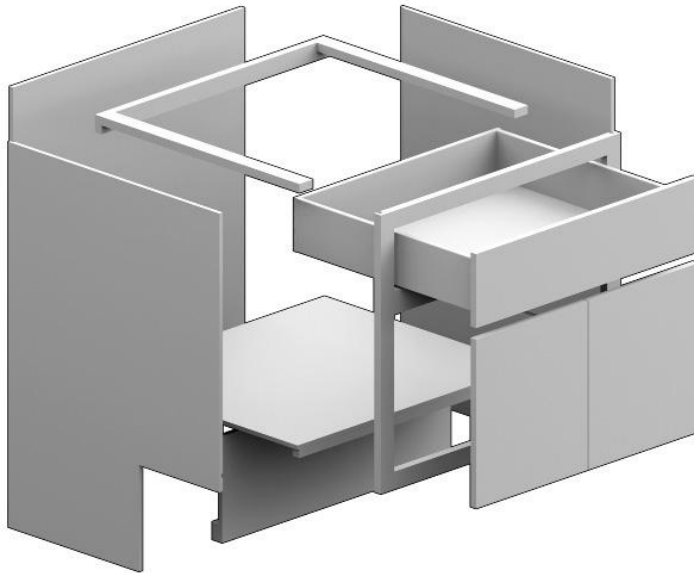

### Cabinet Fronts

- $\frac{3}{4}$ " solid wood
- Front stiles are pocket drilled and assembled with  $1\frac{1}{4}$ " screws for rugged durability

### Side Panels

- $\frac{3}{8}$ " particle board
- **Premium option:  $\frac{3}{8}$ " plywood**
- Vinyl covered on both sides
- Glued and stapled in a  $\frac{3}{8}$ " dado in the cabinet's front frame

### Back Panels

- $\frac{3}{8}$ " particle board
- **Premium option:  $\frac{3}{8}$ " plywood**
- Vinyl covered on inside ONLY
- Glued and nailed in  $\frac{3}{8}$ " dado and stapled to the hang rail and cabinet bottom

### Floor Panels

- $\frac{3}{8}$ " particle board
- **Premium option:  $\frac{3}{8}$ " plywood**
- Vinyl covered on inside ONLY

### Hanging Rails

- $\frac{3}{4}$ " x  $1\frac{1}{2}$ " all wood
- Installed on sides and back

### Toe Kick

**NOTE: Vanity measurements include applied toe kick cover**

- Handicap (HH): 9" H x 9" D; Vanity Base: 9" H x  $8\frac{3}{4}$ " D
- Handicap Accessible (HA):  $5\frac{1}{2}$ " H x 4" D; Vanity Base:  $5\frac{1}{2}$ " H x  $3\frac{5}{8}$ " D

### Shelves (Handicap Accessible ONLY)

- Fixed  $\frac{1}{2}$ " MDF
- **Premium option: Fixed  $\frac{1}{2}$ " plywood**
- Bullnose, foil-covered front edges

### Drawers

- $\frac{1}{2}$ " MDF
- **NOTE: Cabinets 27" - 36" W use  $\frac{1}{2}$ " finished solid wood**
- **Premium option:  $\frac{1}{2}$ " finished solid wood**
- Bullnose, foil-covered top edges
- Dovetail construction standard
- Drawers glide smoothly on self-adjusting ball bearing nylon guides

### Doors

- Butt Doors: Available on 24" W Cabinets, Standard on 27" - 36" W
- Door Construction Specifications are on pages 8-14

### Finish

All cabinet front and door surfaces receive stain and a catalyzed clear or a catalyzed paint finish. Our finish provides a deep, rich wood tone that is resistant to household chemicals, water, food stains and mild acids.

### Hinges

Hidden, self-closing adjustable hinge

### Optional Construction Features

See page 4 for option details

# Cabinet Dimensions

## 84" High Handicap Accessible Applications

**Handicap Accessible Notes**

- 1 1/2" top and bottom rails on base cabinets
- 2" top rail and 1 1/2" bottom rail on tall cabinets
- 3" vertical rails on base cabinets to divide double door cabinets on 39" wide and over
- Toe kick depth: 4"
- Drawer box opening heights are 5 1/4" for small and 7 3/8" or 8 7/8" for large (deep) drawers
- Drawer box depth 20 3/4"

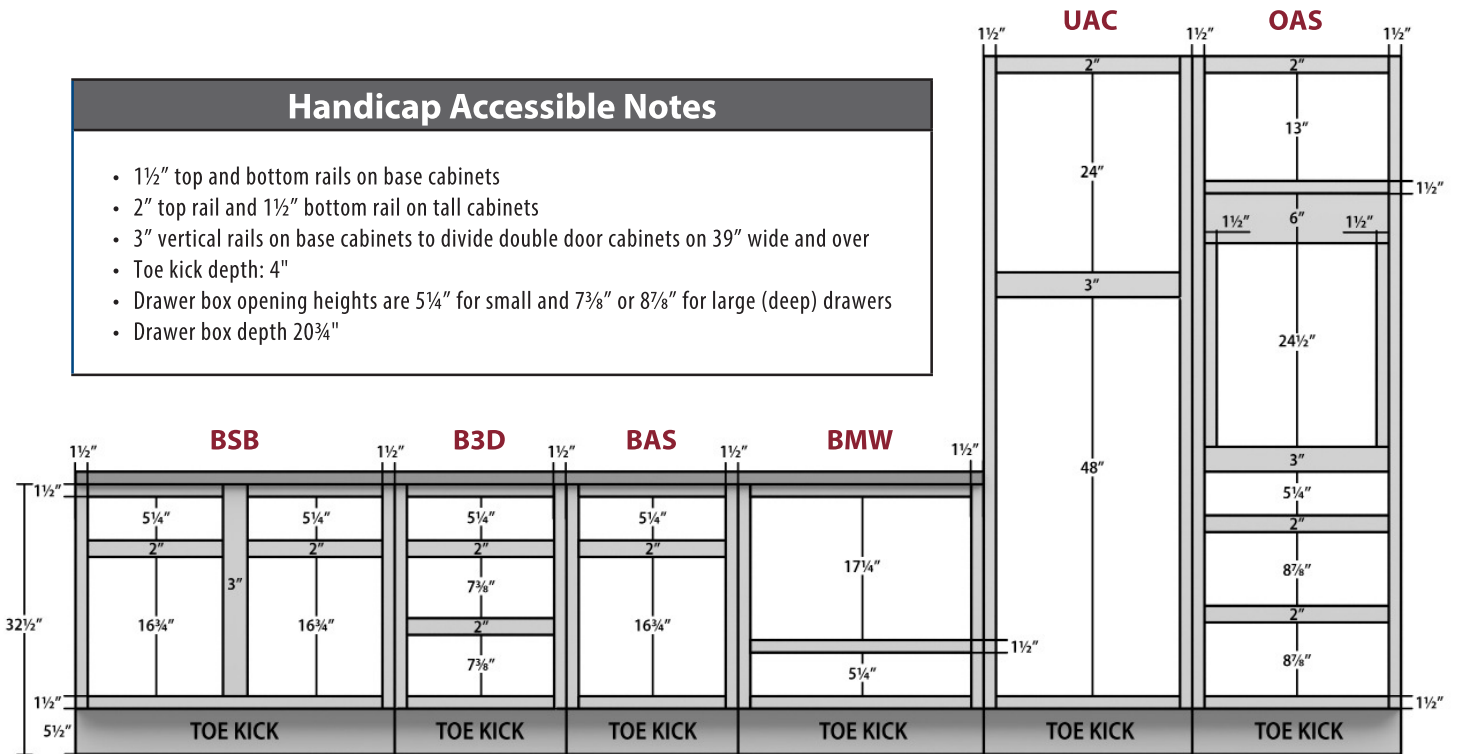

## 90" High Handicap Accessible Applications

## 96" High Handicap Accessible Applications

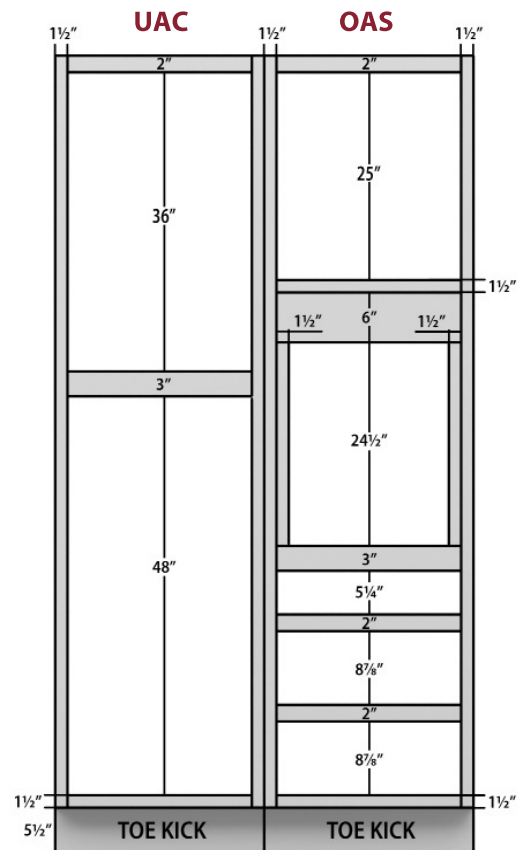
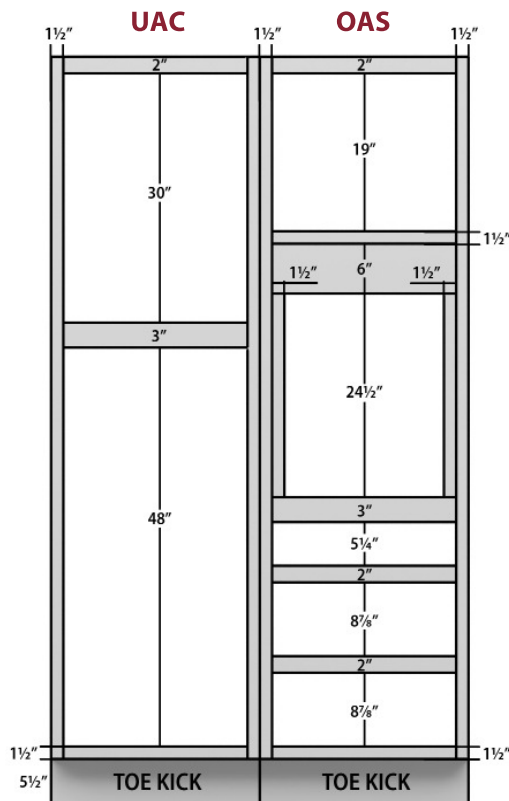

# Cabinet Dimensions

## 84" High Handicap Applications

**Handicap Notes**

- 1 1/2" top and bottom rails on base cabinets
- 2" top rail and 1 1/2" bottom rail on tall cabinets
- 3" vertical rails on base cabinets to divide double door cabinets on 39" wide and over
- Toe kick depth: 9"
- Drawer box opening heights are 5 1/4" for small and 7 3/8" or 8 7/8" for large (deep) drawers
- Drawer box depth 20 3/4"

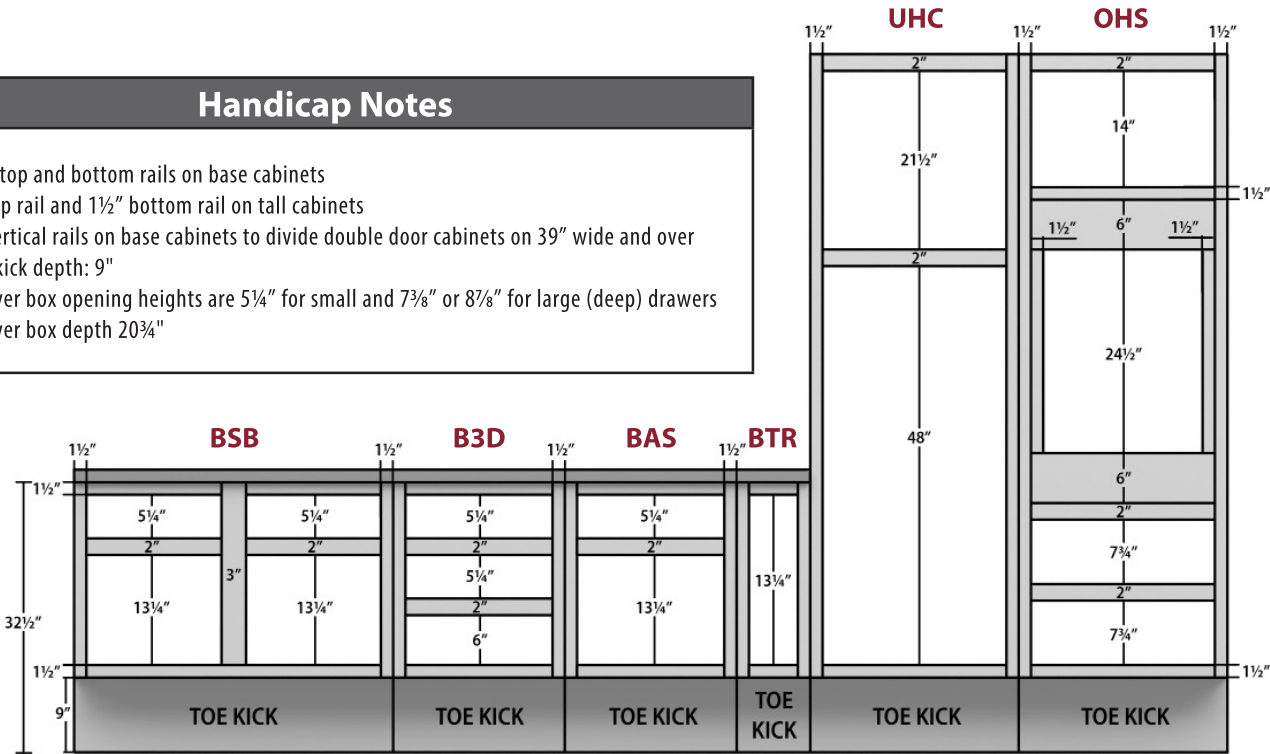

## 90" High Handicap Applications

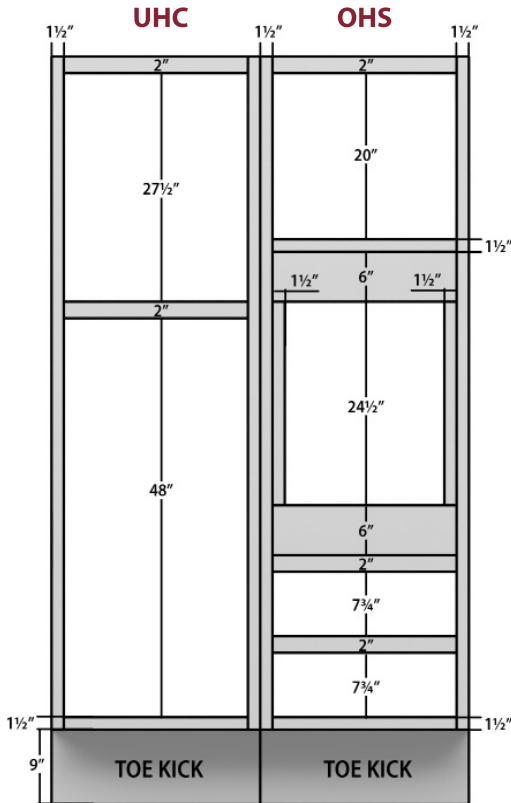

## 96" High Handicap Applications

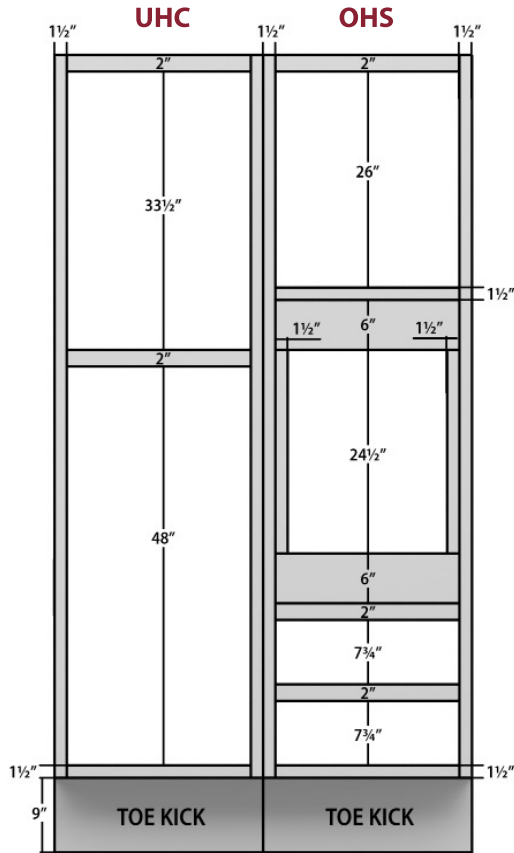

# Cabinet Dimensions

## 32½" High Handicap Accessible Vanity Cabinets

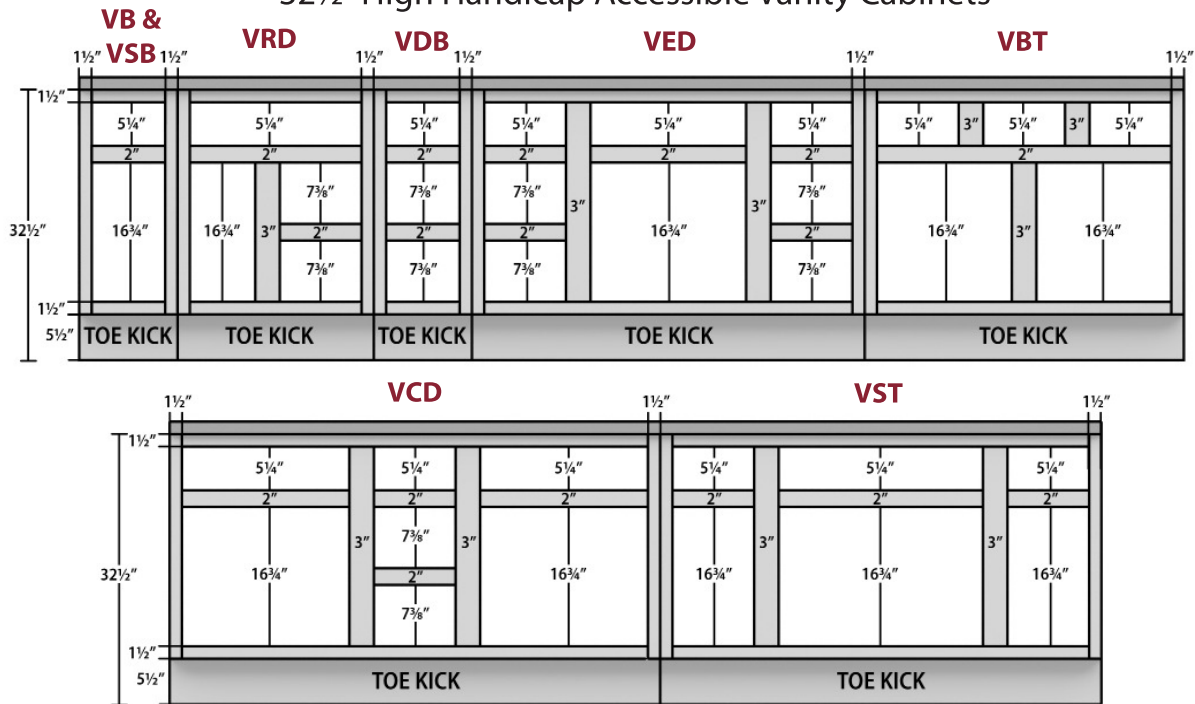

## 32½" High Handicap Vanity Cabinets

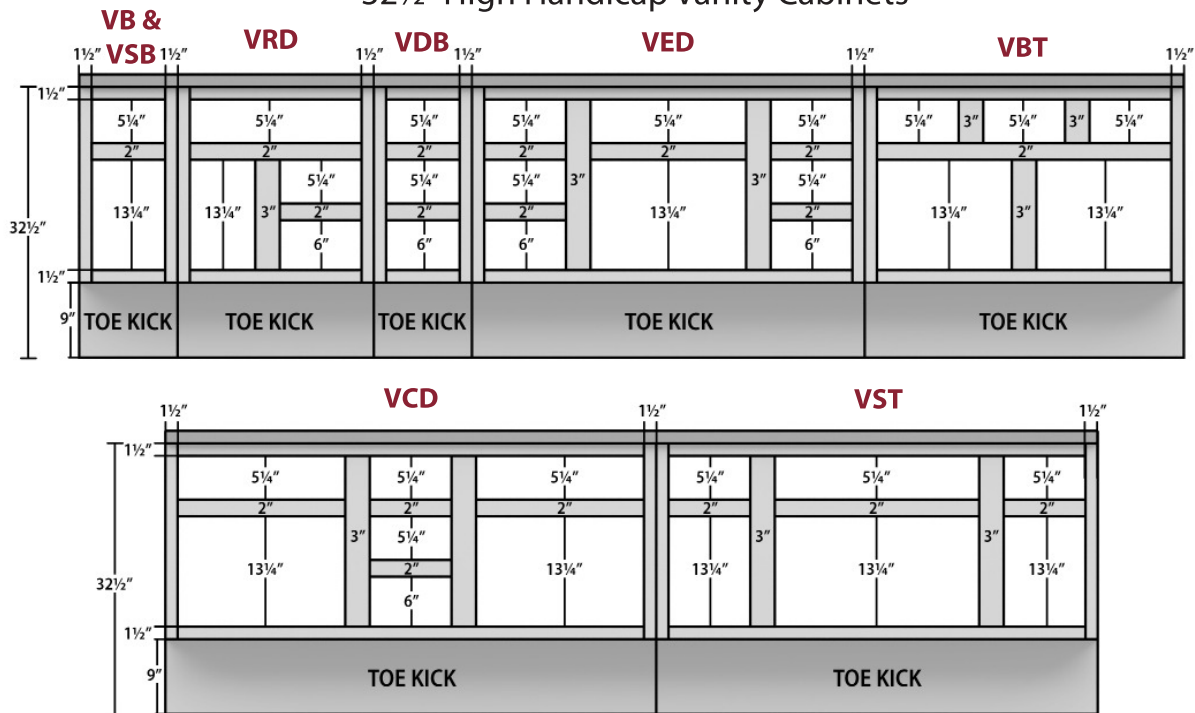

### Notes

- 1½" top and bottom rails
- 3" vertical rails on base cabinets to divide double door cabinets on 39" wide and over
- Toe kick depth: HA 3⅝"; HH 8⅞"
- Drawer box opening heights are 5¼" for small and 6" or 7⅞" for large (deep) drawers
- 21" deep cabinets: MDF drawer box depth 16½", All Wood 18"
- 18" deep cabinets: Drawer box depth 16½"

## Door Overlay Specifications

### Base Cabinets

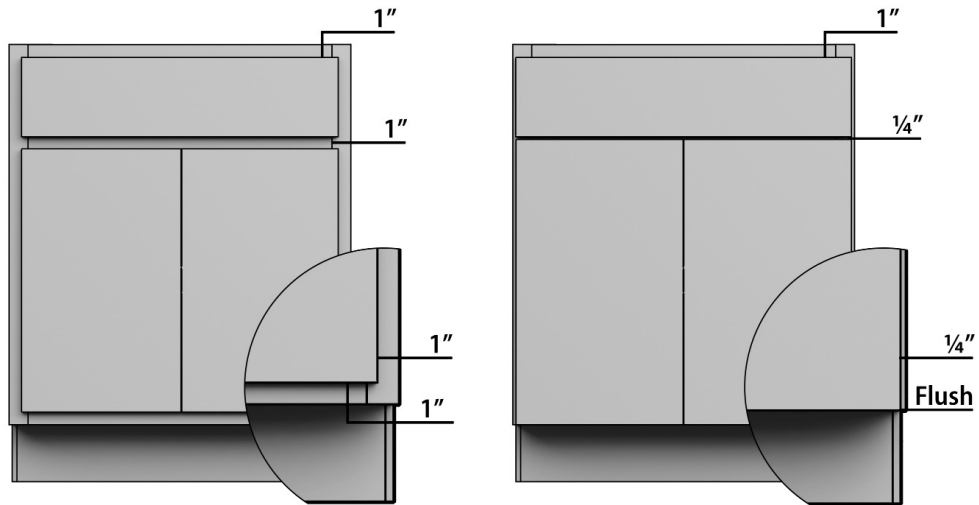

### Base Cabinet Notes

#### Standard Overlay Door Style

- 1" reveal on sides, above, and below of door(s)
- 1" reveal between door(s) and drawer front(s)

#### Full Overlay Door Style

- ¼" reveal on sides of door(s)
- Flush on the bottom of door(s)
- 1" reveal above door(s)
- ¼" reveal between door(s) and drawer front(s)

### Wall Cabinets

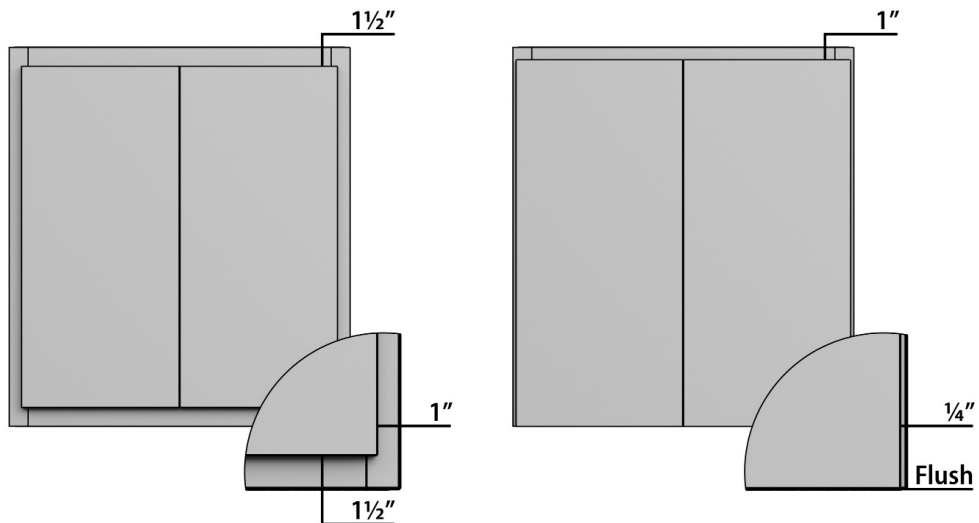

### Wall Cabinet Notes

#### Standard Overlay Door Style

- 1" reveal on sides of door(s)
- 1½" reveal above and below door(s)

#### Full Overlay Door Style

- ¼" reveal on sides of door(s)
- Flush on the bottom of door(s)
- 1" reveal on top of door(s)

## Base Cabinets

### Handicap Base Cabinets 12" - 24" Wide

12 - 24 W  
24 D  
32½ H

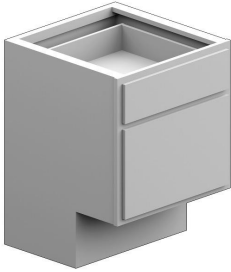

- One door
- Butt doors option available on 24" W ONLY
- One drawer
- One fixed shelf (Handicap Accessible ONLY)

**MODEL NUMBER**  
HB12  
HB15  
HB18  
HB21  
HB24

**ITEM NUMBER**  
BAS1224HH  
BAS1524HH  
BAS1824HH  
BAS2124HH  
BAS2424HH

27 - 36 W  
24 D  
32½ H

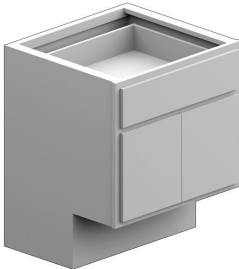

### 27" - 36" Wide

- Butt doors
- One drawer
- One fixed shelf (Handicap Accessible ONLY)

**MODEL NUMBER**  
HB27  
HB30  
HB33  
HB36

**ITEM NUMBER**  
BAS2724HH  
BAS3024HH  
BAS3324HH  
BAS3624HH

39 - 48 W  
24 D  
32½ H

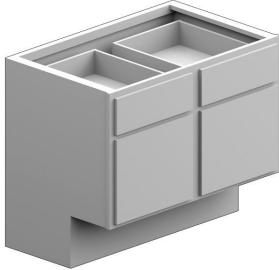

### 39" - 48" Wide

- Two doors
- Two drawers

**MODEL NUMBER**  
HB39  
HB42  
HB45  
HB48

**ITEM NUMBER**  
BAS3924HH  
BAS4224HH  
BAS4524HH  
BAS4824HH

### Handicap Range and Sink Bases 24" Wide

24 W  
24 D  
32½ H

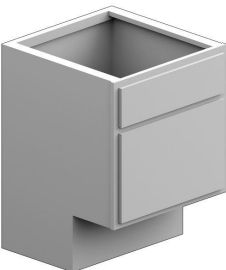

- One door
- Butt doors option available on 24" W ONLY
- No drawer
- No shelves

**MODEL NUMBER**  
HSB24

**ITEM NUMBER**  
BSB2424HH

27 - 36 W  
24 D  
32½ H

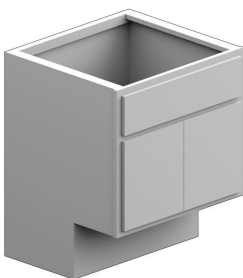

### 27" - 36" Wide

- Butt doors
- No drawer
- No shelves

**MODEL NUMBER**  
HSB27  
HSB30  
HSB33  
HSB36

**ITEM NUMBER**  
BSB2724HH  
BSB3024HH  
BSB3324HH  
BSB3624HH

**Notes:**

- **Handicap Accessible Item Number** - end with HA instead of HH
- **Handicap Accessible Model Number** - begin with HA instead of H
- No peninsula option on HH/HA cabinets
- All shelves and bottoms are rated to withstand 15 lbs. per square foot
- Drawer weight capacity: 75 lbs
- Dovetail drawers standard
- Two hinges per door
- Premium all wood package upgrade available
- Soft close hinge and drawer upgrade available, see page 4
- For additional cabinet options, see page 4

## Base Cabinets

### Handicap Range and Sink Bases 39" - 48" Wide

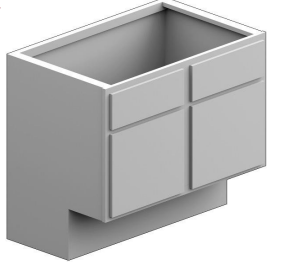
<p>39 - 48 W 24 D 32½ H</p>		<ul style="list-style-type: none"> <li>• Two doors</li> <li>• No drawer</li> <li>• No shelves</li> </ul>	<p><b>MODEL NUMBER</b> HSB39 HSB42 HSB45 HSB48</p>	<p><b>ITEM NUMBER</b> BSB3924HH BSB4224HH BSB4524HH BSB4824HH</p>
-------------------------------------	---	--	--	---

### Handicap 3-Drawer Bank Cabinets

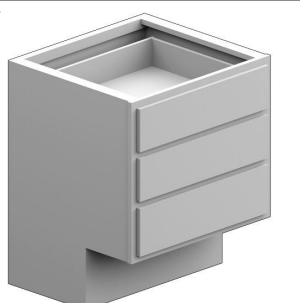
<p>12 - 36 W 24 D 32½ H</p>		<ul style="list-style-type: none"> <li>• Three drawers</li> </ul>	<p><b>MODEL NUMBER</b> H3DB12 H3DB15 H3DB18 H3DB21 H3DB24 H3DB27 H3DB30 H3DB33 H3DB36</p>	<p><b>ITEM NUMBER</b> B3D1224HH B3D1524HH B3D1824HH B3D2124HH B3D2424HH B3D2724HH B3D3024HH B3D3324HH B3D3624HH</p>
-------------------------------------	---	---	---	---

### Handicap Diagonal Sink Bases

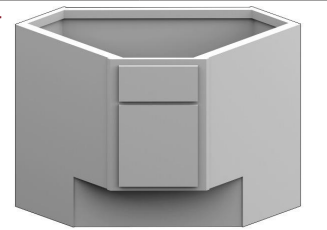
<p>BDI - Face Frame and Floor  BDC - Complete (shown) 36x36 or 42x42 32½ H</p>		<ul style="list-style-type: none"> <li>• One door</li> <li>• No drawers</li> <li>• No shelves</li> </ul>	<p><b>MODEL NUMBER</b> HDSBC36X36 HDSBC42X42 HDSB36X36 HDSB42X42</p>	<p><b>ITEM NUMBER</b> BDC3636HH BDC4242HH BDI3636HH BDI4242HH</p>
--	---	--	--	---

### Handicap Base Angle Cabinets

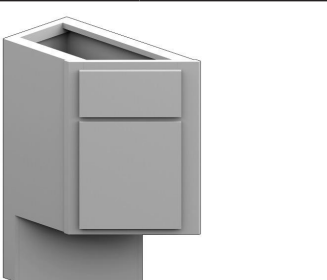
<p>Height: 32½ Short Side: 12 Long Side: 24 Back: 12 Front Face: 17½ Left angle shown Cabinet Angle Degree: 135°</p>		<ul style="list-style-type: none"> <li>• One door</li> <li>• No drawer</li> <li>• One fixed shelf (Handicap Accessible ONLY)</li> <li>• BAR - Right angle cabinet</li> <li>• BAL - Left angle cabinet</li> </ul>	<p><b>MODEL NUMBER</b> HBAC12L</p>	<p><b>ITEM NUMBER</b> BAL1224HH</p>
--	---	--	--	---

**Notes:**

- **Handicap Accessible Item Number** - end with HA instead of HH
- **Handicap Accessible Model Number** - begin with HA instead of H
- No peninsula option on HH/HA cabinets
- All shelves and bottoms are rated to withstand 15 lbs. per square foot
- Drawer weight capacity: 75 lbs
- Dovetail drawers standard
- Two hinges per door
- Premium all wood package upgrade available
- Soft close hinge and drawer upgrade available, see page 4
- For additional cabinet options, see page 4

## Base Cabinets

### Handicap Base Corner Cabinets

BLZ - Lazy Susan w/  
165 Degree Hinge  
Ends: 18

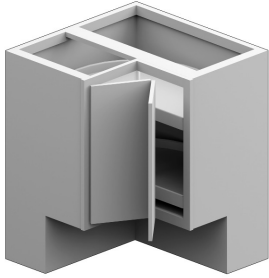

- Easy Reach door
- Two trays
- Tray weight capacity: 75 lbs
- Heavy duty lazy susan wooden tray upgrade available
- NOTE: Soft close hinge upgrade not available

**MODEL NUMBER**  
HBLS3333  
HBLS3636

**ITEM NUMBER**  
BLZ3333HH  
BLZ3636HH

### Handicap Base Super Susan

BDL - Super Susan  
Ends: 23¼

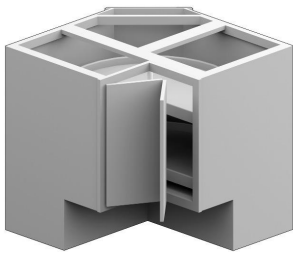

- Easy Reach door
- Two trays
- Tray dimensions: 32" diameter
- Tray weight capacity: 75 lbs
- Heavy duty lazy susan wooden tray upgrade available
- NOTE: Soft close hinge upgrade not available

**MODEL NUMBER**  
HSS36

**ITEM NUMBER**  
BDL3636HH

### Handicap Microwave Base

Microwave Opening:  
HH: 27 W x 13¾ H  
HA: 27 W x 17¼ W

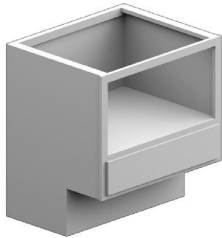

- One drawer

**MODEL NUMBER**  
HBMC30

**ITEM NUMBER**  
BMC3024HH

### Handicap Tray Cabinet

9 W  
24 D  
32½ H



- One door
- No drawers
- No shelves

**MODEL NUMBER**  
HBT9

**ITEM NUMBER**  
BTR0924HH

**Notes:**

- **Handicap Accessible Item Number** - end with HA instead of HH
- **Handicap Accessible Model Number** - begin with HA instead of H
- No peninsula option on HH/HA cabinets
- All shelves and bottoms are rated to withstand 15 lbs. per square foot
- Drawer weight capacity: 75 lbs
- Dovetail drawers standard
- Two hinges per door
- Premium all wood package upgrade available
- Soft close hinge and drawer upgrade available, see page 4
- For additional cabinet options, see page 4



# Blind Cabinets

## Handicap Blind Corner Base Cabinets

1 Door

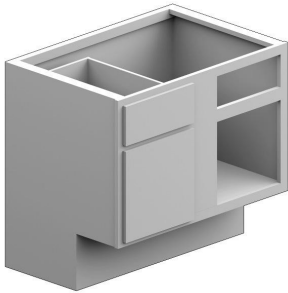

- One door
- One drawer
- One fixed shelf (Handicap Accessible ONLY)
- Specify L or R blind
- Please reference drawings below for (A), (B), (C), (D) cabinet measurements

Specify Right or Left Blind (Right Blind shown)

MODEL NUMBER	ITEM NUMBER	CAB. WIDTH (A)	MIN. S/O (B)	MAX. (C)	MIN. F/O (D)	Door Hardware Clearance F/O		Door Hardware Clearance S/O	
						Min. Pull	Max. Pull	Min. Pull	Max. Pull
HBCC36-39	BCC3624HH	27	37	39	38				
HBCC39-42	BCC3924HH	30	39	42	40				
HBCC42-45	BCC4224HH	36	42	45	43	1 1/16	2 1/16	13/16	2 13/16
HBCC45-48	BCC4524HH	42	45	48	46				
HBCC48-51	BCC4824HH	48	48	51	49				

### Illustration

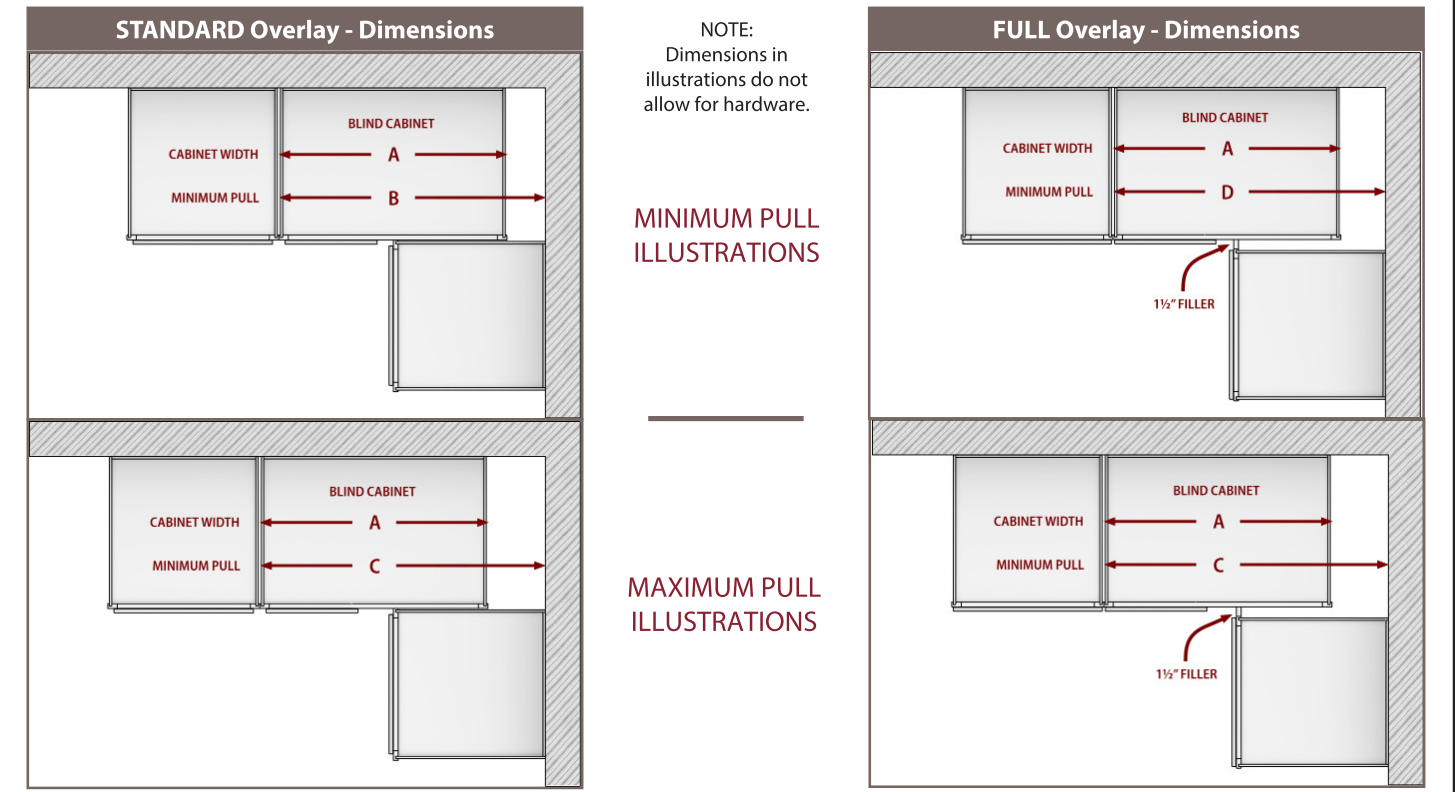

**Notes:**

- **Handicap Accessible Item Number** - end with HA instead of HH
- **Handicap Accessible Model Number** - begin with HA instead of H
- No peninsula option on HH/HA cabinets
- All shelves and bottoms are rated to withstand 15 lbs. per square foot
- Drawer weight capacity: 75 lbs
- Dovetail drawers standard
- Two hinges per door
- Premium all wood package upgrade available
- Soft close hinge and drawer upgrade available, see page 4
- For additional cabinet options, see page 4

## Removable Sink Bases/Oven Cabinets

### Handicap Accessible Brackets and Removable Sink Bases

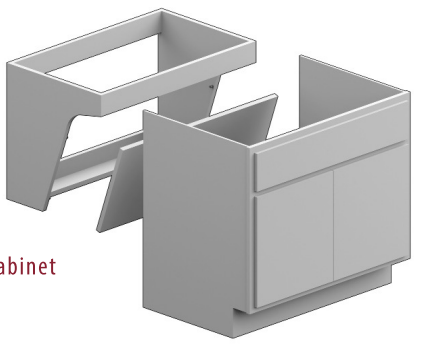
<p>24, 30, 33, 36 W 21 D 32½ H</p> <p>REMOVABLE BASE</p>		<ul style="list-style-type: none"> <li>Handicap Accessible ONLY</li> <li>Includes removeable front panel on bracket</li> <li>One door standard on 24" W sink base; butt doors option available</li> <li>Butt doors on 30", 33", 36" W sink bases</li> </ul>	<p>MODEL NUMBER</p> <p>VBH2421 VBH3021 VBH3321 VBH3621</p>	<p>ITEM NUMBER</p> <p>VBH2421HA VBH3021HA VBH3321HA VBH3621HA</p>
<p>HA Bracket: W 1⅝ less than Cabinet 20 D Bottom 8 D</p>		<p>ADA requirements vary. Always check your local ADA requirements. The installer is responsible for assuring that the installation meets the applicable ADA requirements. Kountry Wood Products, LLC makes no claim as to the compliance of the installed products.</p>		

### Handicap Bracket with Front Panel

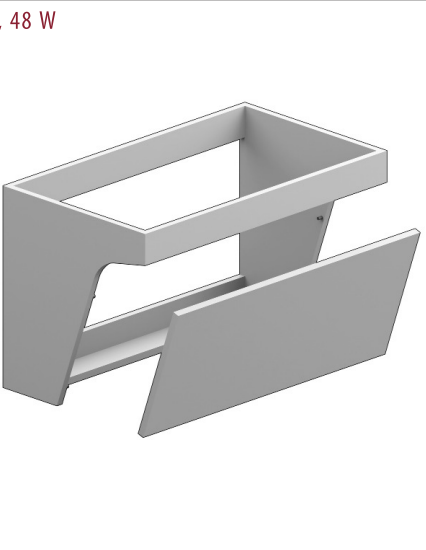
<p>24, 30, 33, 36, 42, 48 W 21, 24 D 22 H Bottom 8 D</p> <p>REMOVABLE FRONT</p>		<ul style="list-style-type: none"> <li>Removeable front panel</li> <li>Sizes are true cabinet width</li> </ul>	<p>MODEL NUMBER</p> <p>AFB24 AFB2424 AFB30 AFB3024 AFB33 AFB3324 AFB36 AFB3624 AFB42 AFB4224 AFB48 AFB4824</p>	<p>ITEM NUMBER</p> <p>AFB242122E AFB242422E AFB302122E AFB302422E AFB332122E AFB332422E AFB362122E AFB362422E AFB422122E AFB422422E AFB482122E AFB482422E</p>
		<p>ADA requirements vary. Always check your local ADA requirements. The installer is responsible for assuring that the installation meets the applicable ADA requirements. Kountry Wood Products, LLC makes no claim as to the compliance of the installed products.</p>		

### Handicap Oven Cabinets

<p>Oven Opening: Height = 27¼" Width = 6" Less than Cabinet Width (Trimmable)</p> <p>27, 30, 33 W 24 D 84, 90, 96 H</p>		<ul style="list-style-type: none"> <li>Butt doors</li> <li>Handicap: two drawers</li> <li>Handicap Accessible (OAS): three drawers</li> <li>Drawers may be removed for Double Oven Cabinet</li> <li>Drilled for shelving, shelf kits sold separately</li> <li>Shelf kits NOT available for 84" H Oven Cabinets</li> <li>Please reference shelf kits (page 35) for shelving options and sizes</li> </ul>	<p>MODEL NUMBER</p> <p>HOC272484 HOC272490 HOC272496 HOC302484 HOC302490 HOC302496 HOC332484 HOC332490 HOC332496</p>	<p>ITEM NUMBER</p> <p>OHS272484 OHS272490 OHS272496 OHS302484 OHS302490 OHS302496 OHS332484 OHS332490 OHS332496</p>
---	---	---	--	---

**Notes:**

- Handicap Accessible Item Number - end with HA instead of HH
- Handicap Accessible Model Number - begin with HA instead of H
- No peninsula option on HH/HA cabinets
- All shelves and bottoms are rated to withstand 15 lbs. per square foot
- Drawer weight capacity: 75 lbs
- Dovetail drawers standard
- Two hinges per door
- Premium all wood package upgrade available
- Soft close hinge and drawer upgrade available, see page 4
- For additional cabinet options, see page 4

## Utility Cabinets

### Handicap Utility Cabinets 84" - 96" Tall

15 - 24 W  
12 - 24 D  
84 - 96 H



24 - 36 W  
24 D  
84 - 96 H



- Two doors
- Butt doors available on cabinet 24", 30", or 36" wide
- Two hinges on top door, three hinges on bottom door
- Drilled for shelving, shelf kits sold separately
- Please reference shelf kits (page 35) for shelving options and sizes
- Premium all wood package upgrade available
- Soft close hinge upgrade available, see page 4
- Glass and mullion available in top doors only

#### 84" Tall

#### 90" Tall

#### 96" Tall

84" Tall		90" Tall		96" Tall	
MODEL NUMBER	ITEM NUMBER	MODEL NUMBER	ITEM NUMBER	MODEL NUMBER	ITEM NUMBER
HUC151284	UHC151284	HUC151290	UHC151290	HUC151296	UHC151296
HUC151884	UHC151884	HUC151890	UHC151890	HUC151896	UHC151896
HUC152184	UHC152184	HUC152190	UHC152190	HUC152196	UHC152196
HUC152484	UHC152484	HUC152490	UHC152490	HUC152496	UHC152496
HUC181284	UHC181284	HUC181290	UHC181290	HUC181296	UHC181296
HUC181884	UHC181884	HUC181890	UHC181890	HUC181896	UHC181896
HUC182184	UHC182184	HUC182190	UHC182190	HUC182196	UHC182196
HUC182484	UHC182484	HUC182490	UHC182490	HUC182496	UHC182496
HUC211284	UHC211284	HUC211290	UHC211290	HUC211296	UHC211296
HUC211884	UHC211884	HUC211890	UHC211890	HUC211896	UHC211896
HUC212184	UHC212184	HUC212190	UHC212190	HUC212196	UHC212196
HUC212484	UHC212484	HUC212490	UHC212490	HUC212496	UHC212496
HUC241284	UHC241284	HUC241290	UHC241290	HUC241296	UHC241296
HUC241884	UHC241884	HUC241890	UHC241890	HUC241896	UHC241896
HUC242184	UHC242184	HUC242190	UHC242190	HUC242196	UHC242196
HUC242484	UHC242484	HUC242490	UHC242490	HUC242496	UHC242496
HUC302484	UHC302484	HUC302490	UHC302490	HUC302496	UHC302496
HUC362184	UHC362184	HUC362190	UHC362190	HUC362196	UHC362196
HUC362484	UHC362484	HUC362490	UHC362490	HUC362496	UHC362496

**Notes:**

- **Handicap Accessible Item Number** - end with HA instead of HH
- **Handicap Accessible Model Number** - begin with HA instead of H
- No peninsula option on HH/HA cabinets
- All shelves and bottoms are rated to withstand 15 lbs. per square foot
- Drawer weight capacity: 75 lbs
- Dovetail drawers standard
- Two hinges per door
- Premium all wood package upgrade available
- Soft close hinge and drawer upgrade available, see page 4
- For additional cabinet options, see page 4

# Shelf Kits

Premium Plywood

Standard Elegant or White

MDF



## MDF

<ul style="list-style-type: none"> <li>Available in two shelf or four shelf kits</li> <li>½" (A4) or ¾" (A6) thickness</li> <li>Elegant color standard: white available to match cabinet interior</li> <li>Shelves are rated to withstand 15 lbs per square foot</li> </ul>	<b>MODEL NUMBER</b>	<b>ITEM NUMBER</b>	<b>MODEL NUMBER</b>	<b>ITEM NUMBER</b>	<b>MODEL NUMBER</b>	<b>ITEM NUMBER</b>	
	2SK2724	2SK2724A4X	4SK1224	4SK1224A4X	4SK1818	4SK1818A4X	
	2SK3024	2SK3024A4X	4SK1512	4SK1512A4X	4SK1821	4SK1821A4X	
	2SK3324	2SK3324A4X	4SK1518	4SK1518A4X	4SK1824	4SK1824A4X	
	2SK2724.75	2SK2724A6X	4SK1521	4SK1521A4X	4SK2112	4SK2112A4X	
2SK3024.75	2SK3024A6X	4SK1524	4SK1524A4X	4SK2118	4SK2118A4X		
2SK3324.75	2SK3324A6X	4SK1812	4SK1812A4X	4SK2121	4SK2121A4X		
<b>MODEL NUMBER</b>	<b>ITEM NUMBER</b>	<b>MODEL NUMBER</b>	<b>ITEM NUMBER</b>	<b>MODEL NUMBER</b>	<b>ITEM NUMBER</b>	<b>ITEM NUMBER</b>	
4SK2124	4SK2124A4X	4SK1224.75	4SK1224A6X	4SK1818.75	4SK1818A6X	4SK2124.75	4SK2124A6X
4SK2412	4SK2412A4X	4SK1512.75	4SK1512A6X	4SK1821.75	4SK1821A6X	4SK2412.75	4SK2412A6X
4SK2418	4SK2418A4X	4SK1518.75	4SK1518A6X	4SK1824.75	4SK1824A6X	4SK2418.75	4SK2418A6X
4SK2421	4SK2421A4X	4SK1521.75	4SK1521A6X	4SK2112.75	4SK2112A6X	4SK2421.75	4SK2421A6X
4SK2424	4SK2424A4X	4SK1524.75	4SK1524A6X	4SK2118.75	4SK2118A6X	4SK2424.75	4SK2424A6X
4SK3024	4SK3024A4X	4SK1812.75	4SK1812A6X	4SK2121.75	4SK2121A6X	4SK3024.75	4SK3024A6X
4SK3624	4SK3624A4X					4SK3624.75	4SK3624A6X

## Premium

<ul style="list-style-type: none"> <li>Available in two shelf or four shelf kits</li> <li>½" (A4-D) or ¾" (A6-D) thickness</li> <li>Elegant color standard: white available to match cabinet interior</li> <li>Shelves are rated to withstand 15 lbs per square foot</li> </ul>	<b>MODEL NUMBER</b>	<b>ITEM NUMBER</b>	<b>MODEL NUMBER</b>	<b>ITEM NUMBER</b>	<b>MODEL NUMBER</b>	<b>ITEM NUMBER</b>	
	2SK2724.5D	2SK2724A4D	4SK1224.5D	4SK1224A4D	4SK1818.5D	4SK1818A4D	
	2SK3024.5D	2SK3024A4D	4SK1512.5D	4SK1512A4D	4SK1821.5D	4SK1821A4D	
	2SK3324.5D	2SK3324A4D	4SK1518.5D	4SK1518A4D	4SK1824.5D	4SK1824A4D	
	2SK2724.75D	2SK2724A6D	4SK1521.5D	4SK1521A4D	4SK2112.5D	4SK2112A4D	
2SK3024.75D	2SK3024A6D	4SK1524.5D	4SK1524A4D	4SK2118.5D	4SK2118A4D		
2SK3324.75D	2SK3324A6D	4SK1812.5D	4SK1812A4D	4SK2121.5D	4SK2121A4D		
<b>MODEL NUMBER</b>	<b>ITEM NUMBER</b>	<b>MODEL NUMBER</b>	<b>ITEM NUMBER</b>	<b>MODEL NUMBER</b>	<b>ITEM NUMBER</b>	<b>ITEM NUMBER</b>	
4SK2124.5D	4SK2124A4D	4SK1224.75D	4SK1224A6D	4SK1818.75D	4SK1818A6D	4SK2124.75D	4SK2124A6D
4SK2412.5D	4SK2412A4D	4SK1512.75D	4SK1512A6D	4SK1821.75D	4SK1821A6D	4SK2412.75D	4SK2412A6D
4SK2418.5D	4SK2418A4D	4SK1518.75D	4SK1518A6D	4SK1824.75D	4SK1824A6D	4SK2418.75D	4SK2418A6D
4SK2421.5D	4SK2421A4D	4SK1521.75D	4SK1521A6D	4SK2112.75D	4SK2112A6D	4SK2421.75D	4SK2421A6D
4SK2424.5D	4SK2424A4D	4SK1524.75D	4SK1524A6D	4SK2118.75D	4SK2118A6D	4SK2424.75D	4SK2424A6D
4SK3024.5D	4SK3024A4D	4SK1812.75D	4SK1812A6D	4SK2121.75D	4SK2121A6D	4SK3024.75D	4SK3024A6D
4SK3624.5D	4SK3624A4D					4SK3624.75D	4SK3624A6D

### White 2 and 4-Shelf Kits

Add "WHX" to the end of the Item Number.  
For Model Number, use "2SKW" / "4SKW" respectively at the beginning.

## Touch-Up Kit



- Contains: top coat, scotch bright pad, fill stick, and felt/stain marker

## Vanity Cabinets

### Handicap Vanity Sink Bases 18" - 24" Wide

18 or 24 W  
16, 18 or 21 D  
32½ H

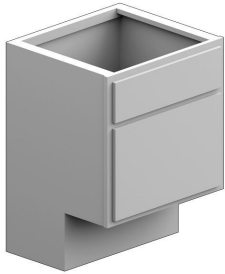

- One door
- Butt doors option available on 24" W ONLY
- No drawer
- Two hinges per door
- No shelves
- Premium all wood package upgrade available
- Soft close hinge upgrade available, see page 4

**MODEL NUMBER**  
HVSB1816  
HVSB1818  
HVSB18  
HVSB2418  
HVSB24

**ITEM NUMBER**  
VSB1816HH  
VSB1818HH  
VSB1821HH  
VSB2418HH  
VSB2421HH

27 - 36 W  
21 D  
32½ H

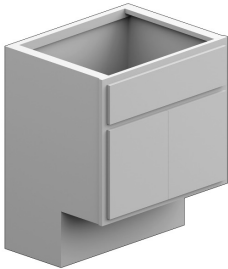

### 27" - 36" Wide

- Butt doors
- No drawer
- Two hinges per door
- No shelves
- Premium all wood package upgrade available
- Soft close hinge upgrade available, see page 4

**MODEL NUMBER**  
HVSB27  
HVSB30  
HVSB33  
HVSB36

**ITEM NUMBER**  
VSB2721HH  
VSB3021HH  
VSB3321HH  
VSB3621HH

39 - 48 W  
21 D  
32½ H

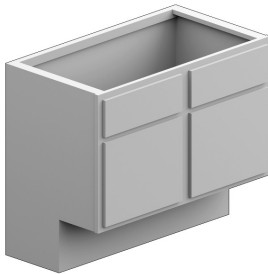

### 39" - 48" Wide

- Two doors
- No drawer
- Two hinges per door
- No shelves
- Premium all wood package upgrade available
- Soft close hinge upgrade available, see page 4

**MODEL NUMBER**  
HVSB39  
HVSB42  
HVSB45  
HVSB48

**ITEM NUMBER**  
VSB3921HH  
VSB4221HH  
VSB4521HH  
VSB4821HH

### Handicap Vanity Sink Bases - Top Drawer 36" Wide

36 W  
21 D  
32½ H

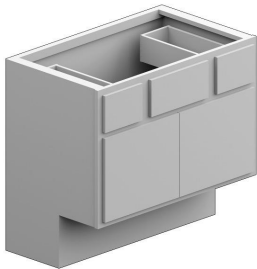

- Butt doors
- Two drawers; one on each end
- Drawer weight capacity: 75 lbs
- Dovetail drawers standard
- Two hinges per door
- No shelves
- Premium all wood package upgrade available
- Soft close hinge and drawer upgrade available, see page 4

**MODEL NUMBER**  
HVBD36

**ITEM NUMBER**  
VBT3621HH

39 - 48 W  
21 D  
32½ H

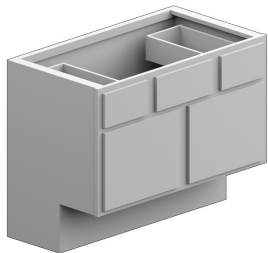

### 39" - 48" Wide

- Two doors
- Two drawers; one on each end
- Drawer weight capacity: 75 lbs
- Dovetail drawers standard
- Two hinges per door
- No shelves
- Premium all wood package upgrade available
- Soft close hinge and drawer upgrade available, see page 4

**MODEL NUMBER**  
HVBD39  
HVBD42  
HVBD48

**ITEM NUMBER**  
VBT3921HH  
VBT4221HH  
VBT4821HH

**Notes:**

- **Handicap Accessible Item Number** - end with HA instead of HH
- **Handicap Accessible Model Number** - begin with HA instead of H
- All vanities include a finished toe kick

- All shelves and bottoms are rated to withstand 15 lbs. per square foot
- Drawer weight capacity: 75 lbs
- Dovetail drawers standard
- Two hinges per door

- Premium all wood package upgrade available
- Soft close hinge and drawer upgrade available, see page 4
- For additional cabinet options, see page 4

## Vanity Cabinets

### Handicap Vanity Base Cabinets 12" - 24" Wide

12 - 24 W  
21 D  
32½ H



- One door
- Butt doors option available on 24" W ONLY
- One drawer
- One fixed shelf (Handicap Accessible ONLY)

**MODEL NUMBER**

HVB12  
HVB15  
HVB18  
HVB21  
HVB24

**ITEM NUMBER**

VAB1221HH  
VAB1521HH  
VAB1821HH  
VAB2121HH  
VAB2421HH

27 - 30 W  
21 D  
32½ H

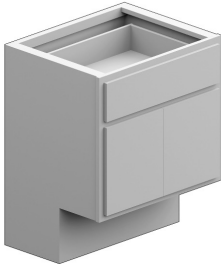

### 27" - 30" Wide

- Butt doors
- One drawer
- One fixed shelf (Handicap Accessible ONLY)

**MODEL NUMBER**

HVB27  
HVB30

**ITEM NUMBER**

VAB2721HH  
VAB3021HH

### Handicap Vanity Sink Bases - Drawer Bank 24" - 30" Wide

24 or 30 W  
18 or 21 D  
32½ H

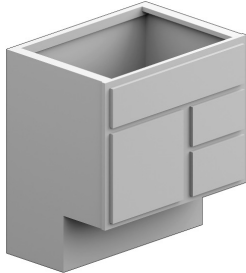

- One door
- Two drawers
- No shelves
- Left drawer bank available: specify VLD instead of VRD

**MODEL NUMBER**

HVRDD2418  
HVRDD24  
HVRDD3018  
HVRDD30

**ITEM NUMBER**

VRD2418HH  
VRD2421HH  
VRD3018HH  
VRD3021HH

36 W  
18 or 21 D  
32½ H

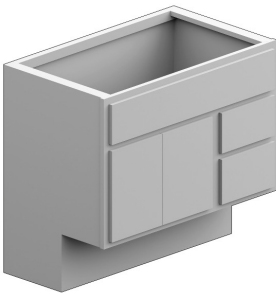

### 36" Wide

- Butt doors
- Two drawers
- No shelves
- Left drawer bank available: specify VLD instead of VRD

**MODEL NUMBER**

HVRDD3618  
HVRDD36

**ITEM NUMBER**

VRD3618HH  
VRD3621HH

42 or 48 W  
18 or 21 D  
32½ H

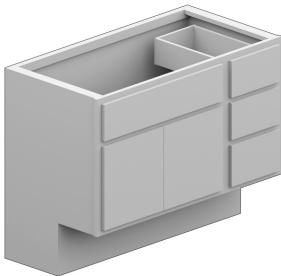

### 42" - 48" Wide

- Butt doors
- Three drawers
- No shelves
- Left drawer bank available: specify VLD instead of VRD

**MODEL NUMBER**

HVRDD4218  
HVRDD42  
HVRDD4818  
HVRDD48

**ITEM NUMBER**

VRD4218HH  
VRD4221HH  
VRD4818HH  
VRD4821HH

**Notes:**

- **Handicap Accessible Item Number** - end with HA instead of HH
- **Handicap Accessible Model Number** - begin with HA instead of H
- All vanities include a finished toe kick
- All shelves and bottoms are rated to withstand 15 lbs. per square foot
- Drawer weight capacity: 75 lbs
- Dovetail drawers standard
- Two hinges per door
- Premium all wood package upgrade available
- Soft close hinge and drawer upgrade available, see page 4
- For additional cabinet options, see page 4

## Vanity Cabinets

### Handicap Vanity Drawers

12 - 24 W  
21 D  
32 1/2 H



- Three drawers

**MODEL NUMBER**  
HVDB12  
HVDB15  
HVDB18  
HVDB21  
HVDB24

**ITEM NUMBER**  
VDB1221HH  
VDB1521HH  
VDB1821HH  
VDB2121HH  
VDB2421HH

### Handicap Vanity Sink Bases - Center Drawer Bank

60 W  
21 D  
32 1/2 H

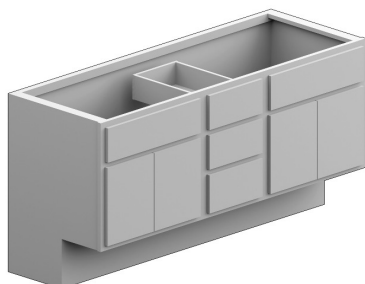

- Butt doors on each end
- Three center drawers
- No shelves

**MODEL NUMBER**  
HVCDD60

**ITEM NUMBER**  
VCD6021HH

### Handicap Vanity Sink Bases - Drawer Bank Each End

48 or 60 W  
18 or 21 D  
32 1/2 H

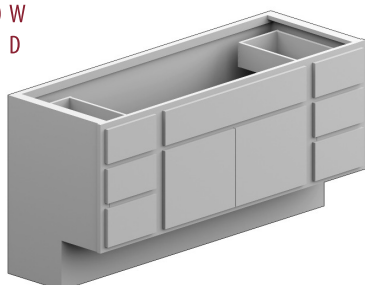

- Butt doors
- Three drawers on each end (6 total)
- No shelves

**MODEL NUMBER**  
HVEDDB4818  
HVEDDB48  
HVEDDB6018  
HVEDDB60

**ITEM NUMBER**  
VED4818HH  
VED4821HH  
VED6018HH  
VED6021HH

### Handicap Vanity Starter Cabinets

54, 60, 72 W  
21 D  
32 1/2 H

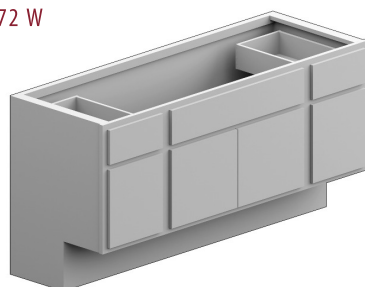

- Center butt doors and one door on each end
- Two drawers
- Two hinges per door
- No shelves

**MODEL NUMBER**  
HVSTB54  
HVSTB60  
HVSTB72

**ITEM NUMBER**  
VST5421HH  
VST6021HH  
VST7221HH

**Notes:**

- **Handicap Accessible Item Number** - end with HA instead of HH
- **Handicap Accessible Model Number** - begin with HA instead of H
- All vanities include a finished toe kick
- All shelves and bottoms are rated to withstand 15 lbs. per square foot
- Drawer weight capacity: 75 lbs
- Dovetail drawers standard
- Two hinges per door
- Premium all wood package upgrade available
- Soft close hinge and drawer upgrade available, see page 4
- For additional cabinet options, see page 4

## Vanity Cabinets

### Handicap Utility Cabinet With Drawers

18 W  
21 D  
80 H



- One door
- Handicap: two drawers
- Handicap Accessible: three drawers
- Drawer weight capacity: 75 lbs
- Dovetail drawers standard
- Two hinges per door
- Three adjustable shelves

**MODEL NUMBER**  
HUT182180  
HAUT182180

**ITEM NUMBER**  
UH2182180  
UA3182180

## Toe Kicks and Panels

### Handicap Toe Kicks

- Available by the piece (P) or by the box (B).
- Boxes come with 12 pieces.
- Available in Handicap (ATH) or Handicap Accessible (ATA).
- ATH: 9" H
- ATA: 5½" H
- Painted finishes (laminated)

**MODEL NUMBER**  
HTK8P  
HTK8B  
HATK8P  
HATK8B

**ITEM NUMBER**  
ATH08A2P  
ATH08A2B  
ATA08A2P  
ATA08A2B

### Handicap Dishwasher Panels with Filler

Dishwasher End Panel  
(shown with 3" filler)

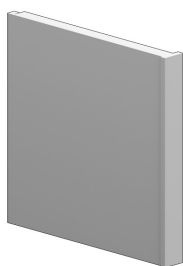

- Available with a 1½" or 3" filler.
- Panel with filler gets cleats on three sides.
- Premium all wood package upgrade available.
- Available in Handicap (HHE) or Handicap Accessible (HAE).

**MODEL NUMBER**  
HDWP1.5  
HDWP3  
HADWP1.5  
HADWP3

**ITEM NUMBER**  
APD0124HHE  
APD0324HHE  
APD0124HAE  
APD0324HAE

### Handicap End Panels with Edge Banding

- ¾" thick plywood (not available in MDF)
- Edge Banding: thin layer of veneer applied along the sides of panel.
- Edge banded on ONE side.
- Finished on both sides; matches the finish of the cabinet.
- Painted finishes (laminated)

**MODEL NUMBER**  
BEP32X.75

**ITEM NUMBER**  
PMV2432A6E





### **Kountry Wood Products Limited Lifetime and Five-Year Warranty**

Kountry Wood cabinets have been manufactured under the highest standards of quality and workmanship.

#### **Lifetime Limited Warranty on Drawer Guides and Hinges**

Kountry Wood Products warrants to original consumer purchasers for as long as they own their home that the drawer, drawer guides and hinges used in the manufacture of Kountry Wood Products cabinetry products shall be free from defects in material and workmanship under normal use.

#### **Five Year Limited Warranty on Cabinets**

In addition, Kountry Wood Products warrants to original consumer purchasers for a period of five-years from the original date of purchase that all other components of Kountry Wood Products cabinetry shall be free from defects in material and workmanship under normal use.

#### **General Warranty Guidelines**

Opaque Finishes are uniquely different from standard wood finishes. On all wood products, expansion and contraction are typical due to changes in climate conditions. Due to this normal movement, Opaque Finishes may develop slight separation lines, finish breaks and seam lines. These will be most notable at stile, rail and panel joints. Joint separations may become more noticeable over time and through season changes. These are normal and are not considered quality defects. Should Kountry Wood Products cabinetry fail during the applicable warranty period due to defects in the material or workmanship under normal use, Kountry Wood Products, at its discretion, will repair or provide the parts necessary to replace the defective products. This warranty does not cover products that are misused, abused, mishandled, improperly installed, improperly stored, changed, modified or subject to extreme temperatures or extreme moisture levels. This warranty is not valid for products used for any purpose other than the purpose for which they were originally intended. This warranty does not cover the cost of installation, removal, subsequent damage or transportation of the defective product, regardless of whether the work was performed by a contractor, service company or the consumer. Variations in color and grain pattern are a natural characteristic of wood. Color changes also may result from exposure to light and other elements that are part of the aging process. These material variations and changes are not covered by this warranty. Kountry Wood Products reserves the right to substitute discontinued product with the most similar product in styling, wood species and color available at the time a claim is submitted.

This warranty is the exclusive warranty of Kountry Wood Products and is in lieu of all other warranties, expressed or implied. In no event shall Kountry Wood Products be liable for consequential, indirect or incidental damages resulting from the installation, use or failure of its product. Some states do not allow the exclusion or limitation of incidental or consequential damages, so the above limitations or exclusions may not apply to you. This warranty gives you specific legal rights and you may also have other rights that vary from state to state. To submit a claim under this warranty, contact your nearest Kountry Wood Products dealer or send a letter explaining the defect along with a dated sales receipt as proof of purchase to:

#### **Kountry Wood Products**

352 Shawnee St - Nappanee, IN 46550

# NOTES

# NOTES

Revision A.1  
Published January 2024

# AMERICAN MADE CABINETRY

Discover the Differences  
Experience the Beauty  
Enjoy all the Options

**Kountry  
WOOD**

CABINETS WORTH OWNING

352 Shawnee St. - Nappanee, IN 46550

Toll Free: 1-888-608-8969

Phone: 574-773-5673

Fax: 574-773-7013

[www.kountrywood.com](http://www.kountrywood.com)



ANSI/KCMA A161.1



KITCHEN CABINET MANUFACTURERS ASSOCIATION  
ENVIRONMENTAL STEWARDSHIP PROGRAM (ESP)  
ALL PRODUCTS IMPACT THE ENVIRONMENT  
FOR ESP PROGRAM CRITERIA, VISIT [KCMA.ORG](http://KCMA.ORG)